

**CATALOGO
2023-2024**

mp
Professional

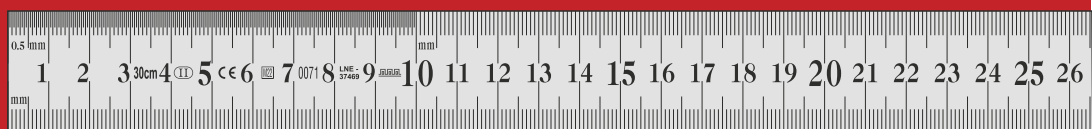

costruzioni misure metriche
www.metroplast.it



CE III

Conforme ai requisiti applicabile della direttiva 2014/32/UE attuata in Italia con Dlgs 84 del 19/05/2016

In compliance with applicable requirements of 2014/32/UE directive, transposed in Italy by Dlgs 84 dated 19/05/2016

Conforme aux dispositions de la directive 2014/32/UE appliqué en Italie par Dlgs 84 du 19/05/2016



CE II

Classe	1m	2m	3m	5m	10m	15m	20m	30m	50m
II	0.2	0.3	0.4	0.6	1.1	1.6	2.1	3.1	5.1
III	0.5	0.7	0.9	1.3	2.3	3.3	4.3	6.3	10.3
III	1.0	1.4	1.8	2.6	4.6	6.6	8.6	12.6	20.6



METRO PLAST 1

PRODUZIONE Via Puccini 15 - 21020 Daverio (VA)

Metro Plast snc è una Azienda leader nel settore degli strumenti di misura. Nata nel 1982 come produttrice di rotelle metriche, in pochi anni ha ampliato la propria gamma di articoli fino a diventare una delle più importanti aziende anche nel settore ferramenta ed edilizia. Vanta una presenza capillare in Italia ed esporta in tutta Europa e nel bacino del mediterraneo. Metro Plast snc produce tuttora le sue conosciute rotelle metriche nello stabilimento di Daverio (VA), adeguando l'esperienza decennale alle tecnologie più moderne, riuscendo a fronteggiare la concorrenza dei produttori asiatici. Le due nuove sedi di Galliate Lombardo (VA) sono solo l'ultimo passo in ordine di tempo per migliorare ulteriormente il servizio che da sempre contraddistingue la società, al pari dell'ottimo rapporto qualità/prezzo. Tutti gli strumenti di misura corrispondono alle direttive europee e sono marcati CE oppure punzonati singolarmente per garantirne la precisione.



METRO PLAST 2

UFFICI Via Vajone 6 - 21020 Galliate L.do (VA)
Tel. +39 0332 947302 - Fax +39 0332 949644

Metro Plast snc is a leader in the field of measuring instruments. It has been established in 1982 as a manufacturer of fibreglass tape measures and in a few years, it has expanded its range to become one of the most important supplier for hardware and construction tools. It has a presence in Italy and exports throughout Europe and the Mediterranean basin. Metro Plast snc still produces its famous tape measures in the site of Daverio (VA), adapting the decades of experience to the new technology to support the requests of the market. The two sites in Galliate Lombardo (VA) are just the latest step in time to further improve the service that has always distinguished the company, like the excellent ratio quality/price. All measuring instruments meet the European directive 2004/22/CE and CE marked.















METRO PLAST 3

MAGAZZINO Via per Daverio 10 - Galliate L.do (VA)

Metro Plast snc est une entreprise leader dans le secteur de la fabrication des instruments de mesure. Fondée en 1982, son activité principale est la fabrication des mesures longues puis, au fil des années sa gamme a été étoffée par des outils pour le bâtiment et la fourniture industrielle. Son influence est aujourd'hui capillaire en Italie et développée à l'export en Europe ainsi que dans tout le bassin méditerranéen. L'unité de production basée à Daverio (VA) a permis à Metro Plast d'acquérir au fil des années une expertise et une technologie de pointe qui répondent aux exigences des nos partenaire. Les 2 sites de Galliate Lombardo (VA) sont destinés au marketing et à la logistique. Tous les emballages et étiquetages des produits sont réalisés en interne; ils permettent une innovation constante et une très grande souplesse pour la personnalisation de tous les produits. Tous les articles de la ligne instruments de mesures répondent à la directive européenne 2004/22/CE et sont estampillés CE.

INDICE - INDEX

	2		38		61
	8		38		62
	15		40		62
	16		43		64
	20		44		65
	22		46		66
	24		50		67
	25		52		67
	26		54		68
	32		55		69
	33		56		70
	34		58		71
	35		58		72
	35		59		72
	36		60		73

ROTELLE - TAPELINE - MESURE LONG

CONFEZIONI - PACKAGING - EMBALLAGE



Confezione Standard
Standard Packaging
Emballage Standard

SERIE
01
02
07
08
09
10
11
14
15
26



a Richiesta - on Demand
PERSONALIZZAZIONE Plastic Bag
CUSTOMIZATION Plastic Bag
PERSONNALISATION Plastic Bag



OPTIONAL
Valigetta PPL Portautensili
Reusable PPL Toolbag
Valise PPL Porte-Outils

SERIE
14



a Richiesta - on Demand
PERSONALIZZAZIONE Valigetta
CUSTOMIZATION Ppl Bag
PERSONNALISATION Valise



OPTIONAL
Blister Bivalva
Clamshell Blister
Blister Coquille

SERIE
02
07
11
15
26



con Card Informativa Neutra
with Neutral Info Card
Card d'Informations Neutre

a Richiesta - on Demand
PERSONALIZZAZIONE Blister + Card
CUSTOMIZATION Blister + Card
PERSONNALISATION Blister + Card

a Richiesta - on Demand
PERSONALIZZAZIONE con Info Card
CUSTOMIZATION with Info Card
PERSONNALISATION avec Info Card



OPTIONAL **GREEN**
Blister Senza Plastica
Blister Plastic-Free
Blister Sans Plastique

SERIE
01
07
08
15



a Richiesta - on Demand
PERSONALIZZAZIONE Senza Plastica
CUSTOMIZATION Plastic Free
PERSONNALISATION Sans Plastique



a Richiesta - on Demand
PERSONALIZZAZIONE Etichetta
CUSTOMIZATION Label on Case
PERSONNALISATION Etiquette



a Richiesta - on Demand
PERSONALIZZAZIONE Tampografia
CUSTOMIZATION Pad Printing
PERSONNALISATION Tampographie

FIBRA DI VETRO - FIBERGLASS - FIBRE DE VERRE

02 - FIBER BLACK



20m

30m

50m



FIBER
Nastro in Fibra di Vetro
Fiberglass Tape
Ruban en Fibre de Verre

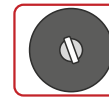

ABS
Custodia in Abs
Abs Case
Boîtier Abs



CLEAN
Facilmente Lavabile
Easy to Wash
Lavable Facilement



RECTO-VERSO
Graduazione Fronte-Retro
Measurement Double Side
Mesure Double Face

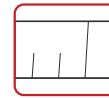

CM
Nastro Centimetrato
Centimeter Tape
Ruban Centimetrique

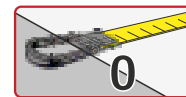

START
Inizio della Graduazione
Beginning of Measurement
Début de la Mesure



Art.	m		€	
01 002 20	20	10		
01 002 30	30	10		
01 002 50	50	10		

07 - FIBER CLASSIC



10m

20m

30m

50m



FIBER
Nastro in Fibra di Vetro
Fiberglass Tape
Ruban en Fibre de Verre



ABS
Custodia in Abs
Abs Case
Boîtier Abs



CLEAN
Facilmente Lavabile
Easy to Wash
Lavable Facilement



RECTO-VERSO
Graduazione Fronte-Retro
Measurement Double Side
Mesure Double Face

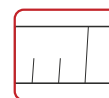

CM
Nastro Centimetrato
Centimeter Tape
Ruban Centimetrique

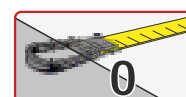

START
Inizio della Graduazione
Beginning of Measurement
Début de la Mesure



Art.	m		€		
01 007 10	10	10			
01 007 20	20	10			
01 007 30	30	10			
01 001 50	50	10			

FIBRA DI VETRO - FIBERGLASS - FIBRE DE VERRE

09 - FIBER GUN



20m

30m

50m



FIBER
Nastro in Fibra di Vetro
Fiberglass Tape
Ruban en Fibre de Verre

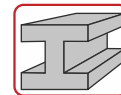

STEEL
Struttura in Acciaio
Steel Frame
Châssis Acier

Manovella di Riavvolgimento in Acciaio
Steel Rewinding Mechanism
Mécanisme de Rembobinage en Acier



CLEAN
Facilmente Lavabile
Easy to Wash
Lavable Facilement

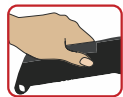

ERGONOMIC
Impugnatura Ergonomica
Ergonomic Handle
Poignée Ergonomique



RECTO-VERSO
Graduazione Fronte-Retro
Measurement Double Side
Mesure Double Face

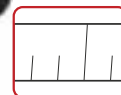

CM
Nastro Centimetrato
Centimeter Tape
Ruban Centimetrique

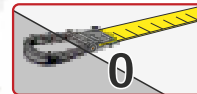

START
Inizio della Graduazione
Beginning of Measurement
Début de la Mesure

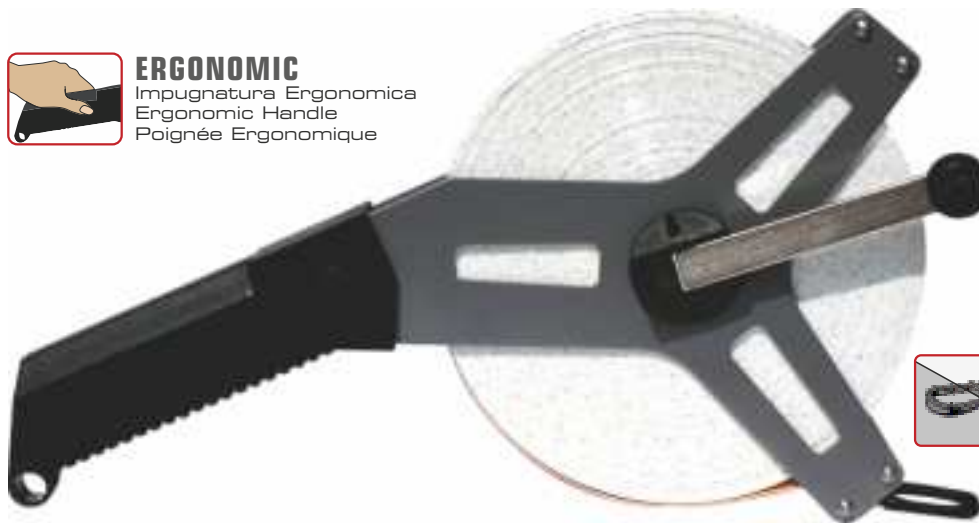

Art.	m		€
01 009 20	20	5	
01 009 30	30	5	
01 009 50	50	5	

10 - FIBER GUN YELLOW VERSION



50m



FIBER YELLOW
Nastro in Fibra Giallo
Yellow Fiberglass Tape
Ruban Jaune en Fibre

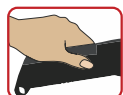

ERGONOMIC
Impugnatura Ergonomica
Ergonomic Handle
Poignée Ergonomique



RECTO-VERSO
Graduazione Fronte-Retro
Measurement Double Side
Mesure Double Face

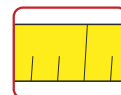

CM
Nastro Centimetrato
Centimeter Tape
Ruban Centimetrique

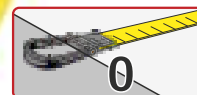

START
Inizio della Graduazione
Beginning of Measurement
Début de la Mesure



Art.	m		€
01 010 50	50	5	

FIBRA DI VETRO - FIBERGLASS - FIBRE DE VERRE

11 - FIBER 4 SPEED



30m

50m



FIBER
Nastro in Fibra di Vetro
Fiberglass Tape
Ruban en Fibre de Verre



4 X
Rientro Veloce
Fast Return
Retour Rapide

Riavvolgimento Rapido del Nastro 4x1
Rapid Rewinding Mechanism 4x1
Rembobinage Rapide Mécanisme 4x1



SOFT - TOUCH
Impugnatura Ergonomica
Ergonomic Handle
Poignée Ergonomique

Custodia Bi-componente
Bi-component Case
Boîtier Bi-matière

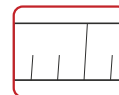

CM
Nastro Centimetrato
Centimeter Tape
Ruban Centimétrique



RECTO-VERSO
Graduazione Fronte-Retro
Measurement Double Side
Mesure Double Face

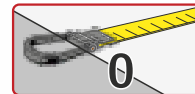

START
Inizio della Graduazione
Beginning of Measurement
Début de la Mesure



Art.	m		€	
01 011 30	30	5		
01 011 50	50	5		

08 - FIBER OPEN



20m

30m

50m



FIBER
Nastro in Fibra di Vetro
Fiberglass Tape
Ruban en Fibre de Verre



ABS OPEN
Custodia Abs Aperta
Abs Open Frame
Châssis Ouvert en Abs

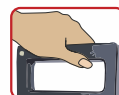

HANDLE
con Impugnatura
with Handle
avec Poignée



CLEAN
Facilmente Lavabile
Easy to Wash
Lavable Facilement



RECTO-VERSO
Graduazione Fronte-Retro
Measurement Double Side
Mesure Double Face

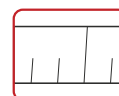

CM
Nastro Centimetrato
Centimeter Tape
Ruban Centimétrique

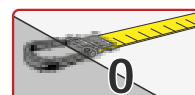

START
Inizio della Graduazione
Beginning of Measurement
Début de la Mesure



Art.	m		€	
01 008 20	20	10		
01 008 30	30	10		
01 008 50	50	10		

NASTRO IN ACCIAIO - STEEL TAPE - RUBAN EN ACIER

14 - GUN STEEL



20m

30m

50m

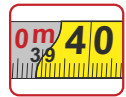

STEEL
Nastro in Acciaio
Steel Tape
Ruban en Acier

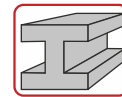

STEEL
Struttura in Acciaio
Steel Frame
Châssis Acier

Manovella di Riavvolgimento in Acciaio
Steel Rewinding Mechanism
Mécanisme de Rembobinage en Acier

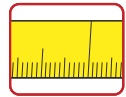

MM
Nastro Millimetrato
Millimeter Tape
Ruban Millimétrique

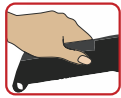

ERGONOMIC
Impugnatura Ergonomica
Ergonomic Handle
Poignée Ergonomique

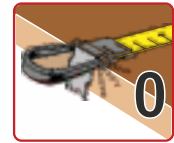

HOOK
Gancio Richiudibile
Folding Hook
Crochet Pliant

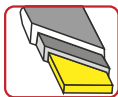

PROTECTIVE
Nastro con Rivestimento Anti-Usura
Wear-Proof Coated Tape
Ruban avec Revêtement Anti-Usure

Art.	m		€	
02 014 20	20	5		
02 014 30	30	5		
02 014 50	50	5		

15 - CLASSIC STEEL



20m

30m

50m



STEEL
Nastro in Acciaio
Steel Tape
Ruban en Acier



ABS
Custodia in Abs
Abs Case
Boîtier Abs



PROTECTIVE
Rivestimento Anti-Usura
Wear-Proof Coated Tape
Revêtement Anti-Usure

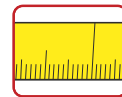

MM
Nastro Millimetrato
Millimeter Tape
Ruban Millimétrique

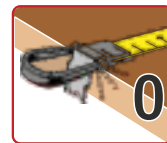

HOOK
con Gancio
Folding Hook
Crochet Pliant

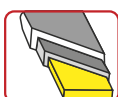

PROTECTIVE
Nastro con Rivestimento Anti-Usura
Wear-Proof Coated Tape
Ruban avec Revêtement Anti-Usure

Art.	m		€		
02 015 20	20	10			
02 015 30	30	10			
02 015 50	50	10			

NASTRO IN ACCIAIO - STEEL TAPE - RUBAN EN ACIER

26 - 4 SPEED STEEL



30m

50m

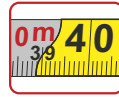

STEEL
Nastro in Acciaio
Steel Tape
Ruban en Acier



4 X
Rientro Veloce
Fast Return
Retour Rapide

Riavvolgimento Rapido del Nastro 4x1
Rapid Rewinding Mechanism 4x1
Rembobinage Rapide Mécanisme 4x1



SOFT - TOUCH
Impugnatura Ergonomica
Ergonomic Handle
Poignée Ergonomique

Custodia Bi-componente
Bi-component Case
Boîtier Bi-matière



MM
Nastro Millimetrato
Millimeter Tape
Ruban Millimétrique



PROTECTIVE
Rivestimento Anti-Usura
Wear-Proof Coated Tape
Revêtement Anti-Usure

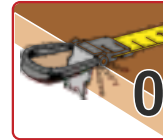

HOOK
con Gancio
Folding Hook
Crochet Pliant



Art.	m		€	
02 026 30	30	5		
02 026 50	50	5		

20 - WHITE STEEL



50m

100m



STEEL
Nastro in Acciaio
Steel Tape
Ruban en Acier



WHITE
Nastro Bianco
White Tape
Ruban Blanc

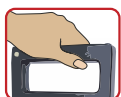

ERGONOMIC
con Impugnatura
with Handle
avec Poignée

Impugnatura Ergonomica
Ergonomic Handle
Poignée Ergonomique



Art.	m		€
02 020 50	50	5	
02 020 00	100	5	

FLESSOMETRI - POCKET TAPES - METRE DE POCHE

CONFEZIONI - PACKAGING - EMBALLAGE

DISPLAY BOX

STANDARD
Scatola / Espositore da Banco
Box / Counter Display
Boîte / Présentoir de Comptoir



a Richiesta - on Demand
PERSONALIZZAZIONE Etichetta
CUSTOMIZATION Label on Case
PERSONNALISATION Etiquette



OPTIONAL
Blister



a Richiesta - on Demand
PERSONALIZZAZIONE Blister + Etichetta
CUSTOMIZATION Blister + Label
PERSONNALISATION Blister + Etiquette

SERIE

65 Card Senza Plastica
71 Card Plastic-Free
72 Card Sans Plastique
80



a Richiesta - on Demand
PERSONALIZZAZIONE Card + Display + Etichetta
CUSTOMIZATION Card + Display Box + Sticker
PERSONNALISATION Card + Display + Etiquette



OPTIONAL GREEN
Blister Senza Plastica
Blister Plastic-Free
Blister Sans Plastique



a Richiesta - on Demand
PERSONALIZZAZIONE Blister + Etichetta
CUSTOMIZATION Blister + Label
PERSONNALISATION Blister + Etiquette

FLEX LOCK

Supporto da Cintura Porta-flessometro
Pocket Tape Belt Holder
Support de Ceinture Pour Metre de Poche



Aggancio Automatico e Sicuro
Sgancio Rapido Tramite Pulsante

Automatic and Safe Hooking
Quick Release by Button

Accrochage Automatique et Sûr
Libération Rapide par Bouton



Blister
LOCK A

Abbinato al Flessometro Richiesto
Combined with Required Pocket Tape
Combiné avec le Mètre Requis

Art. min €
Art + LOCK A 20 0,90



Blister
LOCK B

Art. min €
LOCK B 20 0,90

FLESSOMETRI - POCKET TAPES - METRE DE POCHE

71 - ROCK

CE II

3m

5m

10m



XL
5m - 25mm



XXL
10m - 30mm



TOP
3,0m
5m - 10m



PLANE
2,5m
5m - 10m



EXTRA STRONG
Struttura Robusta
Strong Structure
Boîtier Robuste



COMPACT
Custodia Compatta
Compact Case
Boîtier Compact



PROTECTION
Bi-Componente
Bi-Component
Bi-Matière



GRIP
Antiscivolo
Skid-Proof
Anti-Dérapant



PROTECTIVE
Rivestimento Anti-Usura
Wear-Proof Coated Tape
Revêtement Anti-Usure



MATT
Anti-Riflesso
Anti-Reflective
Antireflet

Art.	m			€		
05 713 19	3m 19	10	50			
05 715 25	5m 25	10	50			
05 710 30	10m 30	5	25			

74 - BI-COMP

CE II

3m

5m

8m

10m



SHINE
Nastro Brillante
Shiny Tape
Ruban Brillant



PROTECTION
Bi-Componente
Bi-Component
Bi-Matière



GRIP
Antiscivolo
Skid-Proof
Anti-Dérapant



PROTECTIVE
Laccatura Protettiva
Protective laquering
Laquage Protecteur

Art.	m			€		
05 743 16	3m 16	10	100			
05 743 19	3m 19	10	100			
05 745 19	5m 19	10	50			
05 745 25	5m 25	10	50			
05 748 25	8m 25	5	25			
05 740 25	10m 25	5	25			



MIRROR
Finitura a Specchio
Mirror Finish
Finition Miroir

81 - TRI-COMP TRI-COMPONENT VERSION

+ 05 81 Sovrapprezzo / Surcharge

FLESSOMETRI - POCKET TAPES - METRE DE POCHE

80 - TURBO RV RECTO-VERSO VERSION

CE II

3m

5m

8m



TOP
3,5m



PLANE
3,0m



STRONG
Struttura Robusta
Strong Structure
Boîtier Robuste



COMPACT
Custodia Compatta
Compact Case
Boîtier Compact



ERGO - GRIP
Ergonomic
Ergonomic
Ergonomique

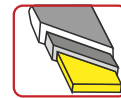

PROTECTIVE
Rivestimento Anti-Usura
Wear-Proof Coated Tape
Revêtement Anti-Usure



MATT
Anti-Riflesso
Anti-Reflective
Antireflet



Art.	m			€		
05 803 28	3m 28	10	50			
05 805 28	5m 28	10	50			
05 808 28	8m 28	5	25			



THICKER
Spessore Maggiorato
Increased Thickness
Epaisseur Accrue



BIG FONT
Numeri Giganti
Giant Numbers
Nombres Geants



28mm XL
5m - 28mm



RECTO-VERSO
Fronte-Retro
Double Side
Double Face



70 - TURBO 1 LATO - 1 SIDE - 1 FACE

CE II

5m

8m

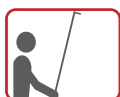

TOP
3,0m



PLANE
2,5m



STRONG
Struttura Robusta
Strong Structure
Boîtier Robuste



COMPACT
Custodia Compatta
Compact Case
Boîtier Compact



ERGO - GRIP
Ergonomic
Ergonomic
Ergonomique



PROTECTIVE
Rivestimento Anti-Usura
Wear-Proof Coated Tape
Revêtement Anti-Usure



MATT
Anti-Riflesso
Anti-Reflective
Antireflet



28mm XL
5m - 28mm
8m - 28mm

Art.	m			€		
05 705 28	5m 28	10	50			
05 708 28	8m 28	5	25			

FLESSOMETRI - POCKET TAPES - METRE DE POCHE

72 - STONE



5m

8m



TOP
3,5m



PLANE
3,0m



SELF-LOCK
Blocco Automatico
Automatic Stop
Autobloquant



POWERFUL
Resiste a Urti e Cadute
Shocks and Falls Resistant
Résistant aux Chocs



PROTECTION
Bi-Componente
Bi-Component
Bi-Matière



GRIP
Antiscivolo
Skid-Proof
Anti-Dérapant

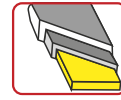

PROTECTIVE
Rivestimento Anti-Usura
Wear-Proof Coated Tape
Revêtement Anti-Usure



MATT
Anti-Riflesso
Anti-Reflective
Antireflet



con Moschettone
with Carabiner
avec Mousqueton



THICKER
Spessore Maggiorato
Increased Thickness
Épaisseur Accrue



32mm
XXL
5m - 32mm
8m - 32mm



BIG FONT
Numeri Giganti
Giant Numbers
Nombres Géants

Art.	m			€	
05 725 32	5m 32	10	50		
05 728 32	8m 32	5	25		

75 - AUTOSTOP



5m



SELF-LOCK
Blocco Automatico
Automatic Stop
Autobloquant



SHIELD
Guscio in Gomma
Rubber Shield
Caoutchouc



GRIP
Antiscivolo
Skid-Proof
Anti-Dérapant



PROTECTIVE
Laccatura Protettiva
Protective laquering
Laquage Protecteur



SHINE
Nastro Brillante
Shiny Tape
Ruban Brillant



MAGNETIC
Puntale Magnetico
Magnetic Hook
Crochet Magnétique



25mm
XL
5m - 25mm



2 STOP
Blocco e Freno
Stop and Brake
Arrêt et Frein

Art.	m			€		
05 755 25	5m 25	10	50			

FLESSOMETRI - POCKET TAPES - METRE DE POCHE

65 - TURBO FLUO

CE II

5m

8m



TOP
3,0m



PLANE
2,5m



STRONG
Struttura Robusta
Strong Structure
Boîtier Robuste



COMPACT
Custodia Compatta
Compact Case
Boîtier Compact



ERGO - GRIP
Ergonomic
Ergonomic
Ergonomique

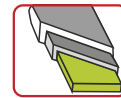

PROTECTIVE
Rivestimento Anti-Usura
Wear-Proof Coated Tape
Revêtement Anti-Usure



MATT
Anti-Riflesso
Anti-Reflective
Antireflet



FLUO



BIG FONT
Numeri Giganti
Giant Numbers
Numbers Geants



HIGH
Alta Visibilità
High Visibility
Haute Visibilité



RECTO-VERSO
Fronte-Retro
Double Side
Double Face



XL
5m - 28mm



MAGNETIC
Gancio Magnetico
Magnetic Hook
Crochet Magnétique

Art.	m			€		
05 655 28	5m 28	10	50		A	G
05 658 28	8m 28	5	25			



87 - BLACK TAPE

CE II

5m



GRIP
Antiscivolo
Skid-Proof
Anti-Dérapant



NYLON
Rivestimento Anti-Usura
Wear-Proof Coated Tape
Revêtement Anti-Usure



MATT
Anti-Riflesso
Anti-Reflective
Antireflet



HIGH
Alta Visibilità
High Visibility
Haute Visibilité



2 STOP
Blocco e Freno
Stop and Brake
Arrêt et Frein



XL
5m - 25mm



RECTO-VERSO
Fronte-Retro
Double Side
Double Face

Art.	m			€		
05 875 25	5m 25	10	50		A	G



FLESSOMETRI - POCKET TAPES - METRE DE POCHE

59 - COMPACT

CE II

- 2m
- 3m
- 5m
- 8m



2 STOP
Blocco e Freno
Stop and Brake
Arrêt et Frein



EXTRA COMPACT
Custodia Compatta
Compact Case
Boîtier Compact



PROTECTIVE
Laccatura Protettiva
Protective laquering
Laquage Protecteur



SHINE
Nastro Brillante
Shiny Tape
Ruban Brillant

Art.	m			€		
05 592 13	2m 13	10	100			
05 593 13	3m 13	10	100			
05 593 16	3m 16	10	100			
05 595 19	5m 19	10	50			
05 595 25	5m 25	10	50			
05 598 25	8m 25	5	25			

63 - CROMO

CE II

- 3m
- 5m
- 8m
- 10m

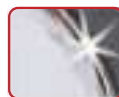

MIRROR
Finitura a Specchio
Mirror Finish
Finition Miroir



EXTRA COMPACT
Custodia Compatta
Compact Case
Boîtier Compact



PROTECTIVE
Laccatura Protettiva
Protective laquering
Laquage Protecteur



SHINE
Nastro Brillante
Shiny Tape
Ruban Brillant

Art.	m			€		
05 633 13	3m 13	10	100			
05 633 16	3m 16	10	100			
05 635 19	5m 19	10	50			
05 635 25	5m 25	10	50			
05 638 25	8m 25	5	25			
05 630 25	10m 25	5	25			

83 - SILVER

CE II

- 3m
- 5m
- 10m



PROTECTION
Bi-Componente
Bi-Matière



GRIP
Antiscivolo
Skid-Proof
Anti-Dérapant



PROTECTIVE
Laccatura Protettiva
Protective laquering
Laquage Protecteur



SHINE
Nastro Brillante
Shiny Tape
Ruban Brillant

Art.	m			€		
05 833 16	3m 16	10	100			
05 835 19	5m 19	10	50			
05 835 25	5m 25	10	50			
05 830 25	10m 25	5	25			

FLESSOMETRI - POCKET TAPES - METRE DE POCHE

60 - COLOR

CE II

3m

5m

8m



COLORED
Custodie Colorate
Colored Cases
Boîtiers Colorées



PROTECTIVE
Laccatura Protettiva
Protective laquering
Laquage Protecteur



SHINE
Nastro Brillante
Shiny Tape
Ruban Brillant

	m			€		
05 603 16	3m 16	12	120			
05 605 19	5m 19	12	120			
05 608 25	8m 25	12	120			

85 - MAGNETIC

CE II

5m



PROTECTION
Bi-Componente
Bi-Component
Bi-Matière



MAGNETIC
Gancio Magnetico
Magnetic Hook
Crochet Magnétique



GRIP
Antiscivolo
Skid-Proof
Anti-Dérapant



PROTECTIVE
Laccatura Protettiva
Protective laquering
Laquage Protecteur



SHINE
Nastro Brillante
Shiny Tape
Ruban Brillant

Art.	m			€		
05 855 25	5m 25	10	50			

84 - DOUBLE STOP

CE II

5m



PROTECTION
Bi-Componente
Bi-Component
Bi-Matière



2 STOP
Blocco e Freno
Stop and Brake
Arrêt et Frein



GRIP
Antiscivolo
Skid-Proof
Anti-Dérapant



PROTECTIVE
Laccatura Protettiva
Protective laquering
Laquage Protecteur



SHINE
Nastro Brillante
Shiny Tape
Ruban Brillant

Art.	m			€		
05 845 19	5m 19	10	50			

57/1 - PORTACHIAVI

CE II

Porta-Chiavi
Key-Chain
Porte-Cles

1m



Art.	m			€
05 571 06	1m 06	25	100	

FLESSOMETRI - POCKET TAPES - METRE DE POCHE

50 - SUN



3m



PROTECTIVE
Laccatura Protettiva
Protective laquering
Laquage Protecteur



SHINE
Nastro Brillante
Shiny Tape
Ruban Brillant



EXTRA COMPACT
Custodia Compatta
Compact Case
Boîtier Compact

Art.	m			€
05 503 13	3m 13	10	100	

07 110 - FLEXI RULE



Riga Flessibile
Flexible Rule
Règle Flexible



MATT
Cromato Opaco
Matt Chrome
Chromé Mat



INOX
Acciaio Inossidabile
Stainless Steel
Acier Inoxydable



15cm

20cm

30cm



Art.	mm			€
07 110 15	150	10	100	
07 110 20	200	10	100	
07 110 30	300	10	100	

07 113 - RIGID RULE



Riga Semi-Rigida
Semi-Rigid Rule
Règle Demi-Rigide



MATT
Cromato Opaco
Matt Chrome
Chromé Mat



INOX
Acciaio Inossidabile
Stainless Steel
Acier Inoxydable

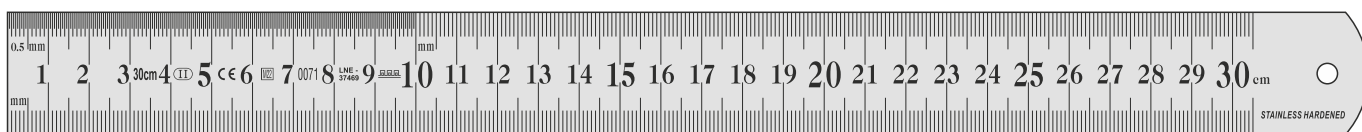

30cm

50cm

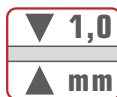

Art.	mm			€
07 113 03	300	10	100	
07 113 05	500	10	100	

07 112 - LONG RULE

1m

Riga Semi-Rigida
Semi-Rigid Rule
Règle Demi-Rigide



MATT
Cromato Opaco
Matt Chrome
Chromé Mat



INOX
Acciaio Inossidabile
Stainless Steel
Acier Inoxydable

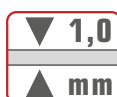
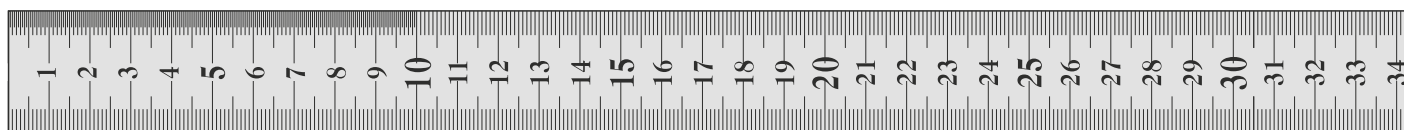

Art.	mm			€
07 112 10	1000	1	5	

DOPPI METRI - FOLDING RULES - METRE PLIANT

CONFEZIONI - PACKAGING - EMBALLAGE



Confezione Standard
Standard Packaging
Emballage Standard



Scatola
Box
Boîte



OPTIONAL
Plastic Bag



a Richiesta - on Demand
PERSONALIZZAZIONE Plastic Bag
CUSTOMIZATION Plastic Bag
PERSONNALISATION Plastic Bag



OPTIONAL GREEN
Blister Senza Plastica
Blister Plastic-Free
Blister Sans Plastique

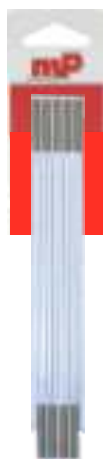

a Richiesta - on Demand
PERSONALIZZAZIONE Senza Plastica
CUSTOMIZATION Plastic-Free
PERSONNALISATION Sans Plastique



OPTIONAL GREEN
Espositore da Banco Senza Plastica
Counter Display Plastic-Free
Presentoir de Comptoir Sans Plastique



Doppio Metro con Card
Folding Rule with Card
Mètre Pliant avec Card



a Richiesta - on Demand
PERSONALIZZAZIONE Espositore e Card
CUSTOMIZATION Display and Card
PERSONNALISATION Presentoir et Card

BARCODE



a Richiesta - on Demand
PERSONALIZZAZIONE Barcode
CUSTOMIZATION Barcode
PERSONNALISATION Barcode

PRINT



a Richiesta - on Demand
PERSONALIZZAZIONE Tampografia
CUSTOMIZATION Pad Printing
PERSONNALISATION Tampographie

DOPPI METRI - FOLDING RULES - METRE PLIANT

39 - BETULLA TOP



Legno di Faggio
Beech Wood
En Hetre



PROTECTIVE

Finitura Anti-Abrasione Resistente a Sporcizia e Umidità
Anti-Abrasion Finish Resistant to Dirt and Moisture
Fini Anti-Abrasion Résistant à la Saleté et à l'Humidité

Rivestito con Smalto a Base d'Acqua e 2 Strati di Vernice Idrosolubile
Water-Based Enamel Coating and 2 Layers of Water-Soluble Paint
Enduit d'émail à Base d'Eau et 2 Couches de Peinture Hydrosoluble



RIVETS

Rivetti a Scomparsa
Hidden Rivets
Rivets Cachés

Art. 04 039 00 m 2m 10 100 € A G F

36 - FAGGIO TOP



Legno di Faggio
Beech Wood
En Hetre



PROTECTIVE

Finitura Anti-Abrasione Resistente a Sporcizia e Umidità
Anti-Abrasion Finish Resistant to Dirt and Moisture
Fini Anti-Abrasion Résistant à la Saleté et à l'Humidité

Rivestito con Smalto a Base d'Acqua e 2 Strati di Vernice Idrosolubile
Water-Based Enamel Coating and 2 Layers of Water-Soluble Paint
Enduit d'émail à Base d'Eau et 2 Couches de Peinture Hydrosoluble



RIVETS

Rivetti a Scomparsa
Hidden Rivets
Rivets Cachés

Art. 04 036 00 m 2m 10 100 € A G F

34 - FAGGIO PRO



Legno di Faggio
Beech Wood
En Hetre



PROTECTIVE

Finitura Anti-Abrasione Resistente a Sporcizia e Umidità
Anti-Abrasion Finish Resistant to Dirt and Moisture
Fini Anti-Abrasion Résistant à la Saleté et à l'Humidité

Rivestito con Smalto a Base d'Acqua e 2 Strati di Vernice Idrosolubile
Water-Based Enamel Coating and 2 Layers of Water-Soluble Paint
Enduit d'émail à Base d'Eau et 2 Couches de Peinture Hydrosoluble

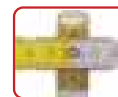

RIVETS

Rivetti a Vista
Visible Rivets
Rivets Visibles

Art. 04 034 00 m 2m 10 100 € A G F

DOPPI METRI - FOLDING RULES - METRE PLIANT

40 - LEGNO FLUO



Doppio Metro in Legno
Wooden Folding Rule
Mètre Pliant en Bois

FLUO



RIVETS
Rivetti a Vista
Visible Rivets
Rivets Visibles



Art.	m			€			
04 040 00	2m	10	100				

30 - DM LEGNO



in Legno
Wood
Bois



Art.	m			€			
04 030 00 ●	2m	10	100				
04 031 00 ●	2m	10	100				
04 033 00 ○	2m	10	100				

28 - DM FIBRA



Fibra di Vetro
Fiberglass
Fibre de Verre



RED
Decimali Rossi
Red Decimals
Décimaux Rouges



HOT
Inciso a Caldo
Hot Engraved
Gravé à Chaud

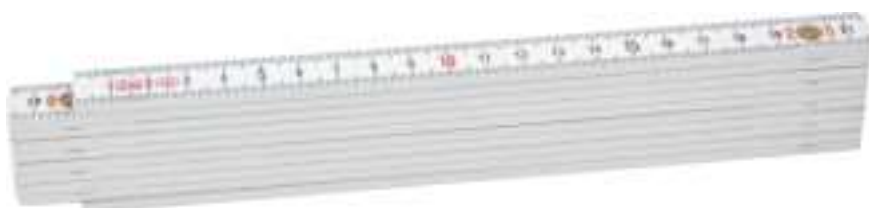

Art.	m			€			
04 028 00	2m	10	100				

DOPPI METRI - FOLDING RULES - METRE PLIANT

DM 02 - STECCA RIBASSATA

Ideale per la Stampa Pubblicitaria
Recommended for Advertising Print
Conseillé pour l'Impression

Spazio di Stampa
Space for Printing
Espace d'Impression

130mm x h6mm



Prima e Ultima Stecca Ribassate
First and Last Rule With Adv. Space
Regles avec Espace Publicitaire

39 02 - BETULLA TOP



Art.	m			€			
04 039 02	2m	10	100				

34 02 - FAGGIO PRO



Art.	m			€			
04 034 02	2m	10	100				

33 02 - DM LEGNO



Art.	m			€			
04 033 02	2m	10	100				

04 A1 - PROMO KIT Doppio Metro a scelta - Folding Rule at Choice - Mètre Pliant au Choix

Matita + Plastic Bag Personalizzato
Pencil + Customized Plastic Bag
Crayon + Plastic Bag Personnalisé

Doppio Metro a scelta
Required Folding Rule
Mètre Pliant requis



Matita + Plastic Bag Personalizzato + Tampografie
Pencil + Customized Plastic Bag + Pad Printings
Crayon + Plastic Bag Personnalisé + Tampographies

Doppio Metro e Tampografia a Scelta
Folding Rule and Pad Printing at Choice
Mètre Pliant et Tampographie au Choix



04 A1 - PROMO KIT

€

+ 04 A1 Sovrapprezzo / Surcharge

04 A2 - PRINTED VERSION

€

+ 04 A2 Sovrapprezzo / Surcharge

MATITE - PENCILS - CRAYONS

CONFEZIONI - PACKAGING - EMBALLAGE

PRINT



a Richiesta - on Demand
PERSONALIZZAZIONE Tampografia
CUSTOMIZATION Pad Printing
PERSONNALISATION Tampographie

BLISTER

STANDARD
 Blister Bivalva
 Clamshell Blister
 Blister Coquille

a Richiesta - on Demand
PERSONALIZZAZIONE Blister + Card
CUSTOMIZATION Blister + Card
PERSONNALISATION Blister + Card

a Richiesta - on Demand
PERSONALIZZAZIONE con Info Card
CUSTOMIZATION with Info Card
PERSONNALISATION avec Info Card



12 060 - TECH MECH

Matita Meccanica Tecnica Funzionamento a Pulsante Autobloccante
 Technical Mechanical Pencil Auto Locking Button System
 Portemine Technique Fonctionnement a Poussoir



con Affilamina
 with Sharpener
 avec Taille Crayon



con Fodero
 with Sheath
 avec Gaine

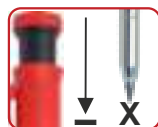

Autobloccante
 Self-Locking
 Autobloquant



Fine



Pratico



Preciso

Art.

12 060 00

●
 2,8mm

☒
 12

€

EX

12 067 - MINE 2,8

HB

Mine Nere in Grafite HB - n.6pz
 Graphite Black HB Leads - n.6pcs
 Mines Noires HB Graphite - n.6pcs

BLISTER KIT

Kit Matita + Fodero + Mine
 Kit Pencil + Sheath + Leads
 Jeu Crayon + Gaine + Mines



Art.
 12 067 B6

n.
 x6

☒
 12

€



Art.
 12 060 B6

●

☒
 12

€

BE



Mine Morbide per Tutte le Superfici - n.6pz
 Soft Leads All-Surface Version - n.6pcs
 Mines Tendres pour Toutes Surfaces - n.6pcs



12 067 R6

x6

12



12 060 R6

●

12

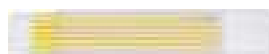

12 067 Y6

x6

12



12 060 Y6

●

12



EX

DISPLAY BOX

OPTIONAL
 Espositore da Banco
 Counter Display
 Présentoir de Comptoir

BE

12 060 EX 12 + 12 in display box

12 Matite con Fodero
 12 Pencils with Sheath
 12 Crayons avec Gaine

12 Mine 4● 4● 4●
 12 Leads 4● 4● 4●
 12 Mines 4● 4● 4●

12 060 BE 12 Blister Kit in display box

Matita + Fodero + Mine ●
 Pencil + Sheath + Leads ●
 Crayon + Gaine + Mines ●



MATITE - PENCILS - CRAYONS

CONFEZIONI - PACKAGING - EMBALLAGE

PRINT



a Richiesta - on Demand
PERSONALIZZAZIONE Tampografia
CUSTOMIZATION Pad Printing
PERSONNALISATION Tampographie



OPTIONAL
 + 3 Mine
 + 3 Leads
 + 3 Mines



OPTIONAL
 + 6 Mine
 + 6 Leads
 + 6 Mines

a Richiesta - on Demand
PERSONALIZZAZIONE Blister + Card
CUSTOMIZATION Blister + Card
PERSONNALISATION Blister + Card

a Richiesta - on Demand
PERSONALIZZAZIONE con Info Card
CUSTOMIZATION with Info Card
PERSONNALISATION avec Info Card

12 072 - MECH 2

Funzionamento a Vite
 Locking Screw System
 Fonctionnement a Vis

Ø 5,6



Art.   €  
 12 072 00 5,6 12

12 075 - MECH 3

Funzionamento a Vite
 Locking Screw System
 Fonctionnement a Vis

Ø 5,6



Art.   €  
 12 075 00 5,6 12

12 082 - RED MECH

Funzionamento a Pulsante
 Locking Button System
 Fonctionnement a Poussoir

Ø 5,6



Art.   €  
 12 082 00 5,6 12

12 083 - MECH SHARP

Funzionamento a Pulsante
 Locking Button System
 Fonctionnement a Poussoir

Ø 5,6



con Affilamina
 with Sharpener
 avec Taille Crayon

Art.   €  
 12 083 00 5,6 12

12 080 - MINE 5,6



Mine di Ricambio
 Spare Leads
 Mines de Rechange



per Muratore, Carpentiere, Falegname, Marmista
 for Mason, Carpenter, Joiner, Marble Workers
 pour Maçon, Menuisier, Charpentier, Marbrier

Art.	n.		€
12 080 B3	3	12	
12 080 B6	6	12	

MATITE - PENCILS - CRAYONS

CONFEZIONI - PACKAGING - EMBALLAGE



OPTIONAL
Plastic Bag



Kit 4 matite
Set 4 pencils
Jeu 4 crayons

a Richiesta - on Demand
PERSONALIZZAZIONE Plastic Bag
CUSTOMIZATION Plastic Bag
PERSONNALISATION Plastic Bag



OPTIONAL
Kit Plastic Bag



Kit 4 matite + Temperamatite
Set 4 pencils + Sharpener
Jeu 4 crayons + Taille Crayon

a Richiesta - on Demand
PERSONALIZZAZIONE Plastic Bag
CUSTOMIZATION Plastic Bag
PERSONNALISATION Plastic Bag

PRINT



Stampa - Printing - Impression
130mm x h6mm

a Richiesta - on Demand
PERSONALIZZAZIONE Tampografia
CUSTOMIZATION Pad Printing
PERSONNALISATION Tampographie



OPTIONAL
Espositore da Banco
Counter Display
Presentoir de Comptoir



30 x4 Matite in Plastic Bag
30 x4 Pencils in Plastic Bag
30 x4 Crayons en Plastic Bag



a Richiesta - on Demand
PERSONALIZZAZIONE Espositore
CUSTOMIZATION Display
PERSONNALISATION Presentoir

12 070 - SHARP

Temperamatite
Sharpener
Taille Crayon



OPTIONAL
Blister

Art.
12 070 00

24

€



MATITE - PENCILS - CRAYONS



H

per Muratore, Marmista
for Mason, Marble Workers
pour Maçon, Marbrier

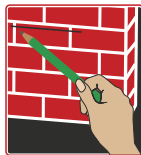

HB

per Carpentiere, Falegname
for Carpenter, Joiner
pour Menuisier, Charpentier



12 097 - GREEN MAT _____



Art.	cm			€			
12 097 25	25	100	1000				

12 098 - RED MAT _____



Art.	cm			€			
12 098 18	18	100	1000				
12 098 25	25	100	1000				

12 094 - GREEN MAT PRO _____



Art.	cm			€			
12 094 25	25	144	1008				

12 095 - RED MAT PRO _____



Art.	cm			€			
12 095 18	18	144	1008				
12 095 25	25	144	1008				

12 084 - GREEN MAT EXTRA _____



Art.	cm			€			
12 084 25	25	144	1008				
12 084 30	30	144	1008				

12 085 - RED MAT EXTRA _____



Art.	cm			€			
12 085 25	25	144	1008				
12 085 30	30	144	1008				

12 091 - GLASS _____



18

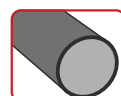
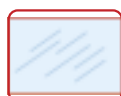
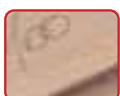

per Tutte le Superfici
All-Surface
Toutes Surfaces



Art.	cm			€	
12 091 01	● 18	100	1000		
12 091 02	● 18	100	1000		
12 091 03	● 18	100	1000		

MARCATORI - MARKERS - MARQUERS

12 110 - EASY



18

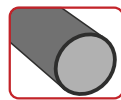
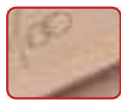

per Tutte le Superfici
All-Surface
Toutes Surfaces



Sempre Pronta all'Uso
Always Ready for Use
Toujours Prêt à l'Emploi

Art.	cm			€	
12 110 01	● 18	20	100		
12 110 03	● 18	20	100		
12 110 06	○ 18	20	100		

12 290 - PASTELLO

Prezzo per astuccio da "n." pastelli - Price for box of "n." crayons - Prix pour confection de "n." crayons

12pcs

04 4pcs

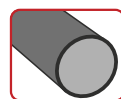
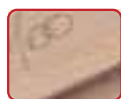
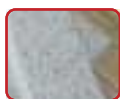

12 x 12 mm



Pastello Industriale
Hexagonal Crayon
Crayon Industriel



Art.	n.			€	
12 292 12	● 12	12	36		
12 293 12	● 12	12	36		
12 295 12	● 12	12	36		

12 310 - STEATITE

Prezzo per astuccio da "n." gessi - Price for box of "n." chalks - Prix pour confection de "n." craies

12pcs



10 x 10 mm

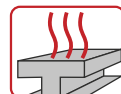
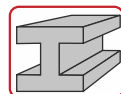

per Scrivere su Acciaio e Ferro, Resistente al Calore
Marking on Steel and Iron, Heat-Resistant
pour Écrire sur Acier et Fer, Résistante à la Chaleur

Art.	n.			€
12 310 12	12	12	36	

12 301 - QUADRO

Prezzo per astuccio da "n." gessi - Price for box of "n." chalks - Prix pour confection de "n." craies

12pcs



12 x 12 mm

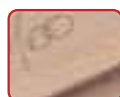
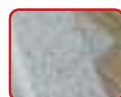

Gesso quadro
Chalk squared
Craie carré

Art.	n.			€
12 301 12	12	12	36	

MARCATORI - MARKERS - MARQUEURS

CONFEZIONI - PACKAGING - EMBALLAGE

BOX

Confezione Standard
Standard Packaging
Emballage Standard



a Richiesta - on Demand
PERSONALIZZAZIONE Pennarello + Scatola
CUSTOMIZATION Marker + Box
PERSONNALISATION Marqueur + Boîte

Scatola
Box
Boîte

a Richiesta - on Demand
PERSONALIZZAZIONE solo Scatola
CUSTOMIZATION Marker Box only
PERSONNALISATION seulement Boîte

DISPLAY BOX

OPTIONAL GREEN
Espositore da Banco Senza Plastica
Counter Display Plastic-Free
Presentoir de Comptoir Sans Plastique



Permanent 48 x ● ● ● ●
12 199 10 144pcs

Paint 24 x ● ● ● ● ● ● ●
12 190 00 144pcs

Paint 12 x ● ● ● ● ● ● ●
12 190 72 72pcs

a Richiesta - on Demand
PERSONALIZZAZIONE
Pennarello + Espositore
CUSTOMIZATION
Marker + Display
PERSONNALISATION
Marqueur + Presentoir

B

OPTIONAL
Blister Bivalva
Clamshell Blister
Blister Coquille



a Richiesta - on Demand
PERSONALIZZAZIONE Pennarello + Blister
CUSTOMIZATION Marker + Blister
PERSONNALISATION Marqueur + Blister

12 199 - PERMANENT

PENNARELLO INDELEBILE
PERMANENT MARKER
MARQUEUR PERMANENT



- per Metallo, Cartone, Gomma, Plastica, Vetro, Pietre, Ceramica
- for Metal, Cardboard, Rubber, Plastic, Glass, Stones, Ceramic
- pour Métal, Carton, Gomme, Plastique, Verre, Pierres, Céramique

Base Alcool - Non Tossico
Alcohol Base - Non Toxic
Base Alcool - Non Toxique



Art.	●	●	●	●	€
12 199 01	●	10	100		
12 199 02	●	10	100		
12 199 03	●	10	100		
12 199 06	○	10	100		
12 199 10	48 x ● ● ● ●				display box - 144pcs

12 190 - PAINT

PENNARELLO A VERNICE
PAINT MARKER
MARQUEUR À PEINTURE



- per Metallo, Cartone, Gomma, Plastica, Vetro, Pietre, Ceramica
- for Metal, Cardboard, Rubber, Plastic, Glass, Stones, Ceramic
- pour Métal, Carton, Gomme, Plastique, Verre, Pierres, Céramique



Art.	●	●	●	●	●	●	●	●	€	B
12 190 01	●	12	60							
12 190 02	●	12	60							
12 190 03	●	12	60							
12 190 04	●	12	60							
12 190 05	●	12	60							
12 190 06	○	12	60							
12 190 00	24 x ● ● ● ● ● ● ●								display box - 144pcs	
12 190 72	12 x ● ● ● ● ● ● ●								display box - 72pcs	

CUTTER

CONFEZIONI - PACKAGING - EMBALLAGE



Confezione Standard
Standard Packaging
Emballage Standard



a Richiesta - on Demand
PERSONALIZZAZIONE Plastic Bag
CUSTOMIZATION Plastic Bag
PERSONNALISATION Plastic Bag



BASE
Blister Bivalva
Clamshell Blister
Blister Coquille



a Richiesta - on Demand
PERSONALIZZAZIONE Blister + Card
CUSTOMIZATION Blister + Card
PERSONNALISATION Blister + Card

a Richiesta - on Demand
PERSONALIZZAZIONE con Info Card
CUSTOMIZATION with Info Card
PERSONNALISATION avec Info Card



OPTIONAL GREEN
Espositore da Banco Senza Plastica
Counter Display Plastic-Free
Presentoir de Comptoir Sans Plastique

SERIE
131
135
139
143



Cutter con Card
Cutter with Card
Cutter avec Card



a Richiesta - on Demand
PERSONALIZZAZIONE Espositore e Card
CUSTOMIZATION Display and Card
PERSONNALISATION Presentoir et Card



OPTIONAL GREEN
Blister Senza Plastica
Blister Plastic-Free
Blister Sans Plastique



a Richiesta - on Demand
PERSONALIZZAZIONE Senza Plastica
CUSTOMIZATION Plastic-Free
PERSONNALISATION Sans Plastique

UTILIZZO ANTINFORTUNISTICO - SAFETY USE - USAGE DE SÉCURITÉ



SAFE
Rientro Automatico
Safety Use
Usage de Sécurité

SERIE
123
125
129



Rilasciando il Pulsante la Lama Rientra Automaticamente
Realising the Button, the Blade Retracts Automatically
En Relâchant le Bouton, la Lame se Rétracte Automatiquement



SAFE PLUS
Meccanismo Speciale
Special Mechanism
Mécanisme Spécial

SERIE
122
149
153



e Inoltre
and Plus
et en Plus



Perso il Contatto con la Superficie, La Lama Rientra Automaticamente, Anche A Pulsante Premuto
Lost Contact with Surface, the Blade Automatically Retracts Even When the Button is Pressed
Sans Contact avec la Surface, la Lame se Rétracte Automatiquement même si le Bouton est Enfoncé

CUTTER

139 - GOMMATO

9

18



AUTO-LOCK
Auto-Bloccaggio
Self-Locking
Autobloquant



SILVER
Lama Argento
Silver Blade
Lame Argent

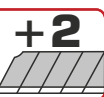

+2 STORE
+2 Lama Include all' Interno
+2 Blades Included Inside
+2 Lames à l' Intérieur

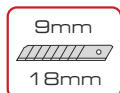

9mm 06 194 10 - 06 194 20
18mm Ricambi - Spares - Rechange
06 190 10 - 06 190 20

Art.			€			
06 139 09	9mm	24				
06 139 18	18mm	12				

131 - HELIX

18

25



KNOB-LOCK
Pomello a Vite
Knob-Locking
Bouton à Vis



SILVER
Lama Argento
Silver Blade
Lame Argent

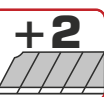

+2 STORE
+2 Lama Include all' Interno
+2 Blades Included Inside
+2 Lames à l' Intérieur

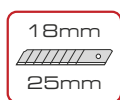

18mm 06 190 10 - 06 190 20
25mm Ricambi - Spares - Rechange
06 193 10 - 06 193 20

Art.			€			
06 131 18	18mm	12				
06 131 25	25mm	12				

135 - SHARPY

18



AUTO-LOCK
Auto-Bloccaggio
Self-Locking
Autobloquant



SILVER Sk4
Lama Argento
Silver Blade
Lame Argent



STRONG
Leggero e Robusto
Light and Strong
Léger et Robuste

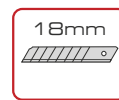

18mm 06 190 20
Ricambi - Spares

Art.			€			
06 135 18	18mm	12				

126 - TINNY

9

18



AUTO-LOCK
Auto-Bloccaggio
Self-Locking
Autobloquant



SILVER Sk4
Lama Argento
Silver Blade
Lame Argent



METAL
Scocca in Metallo
Metal Body
Métallique

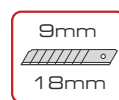

9mm 06 194 20
18mm Ricambi - Spares
06 190 20

Art.			€		
06 126 09	9mm	24			
06 126 18	18mm	12			

CUTTER

156 - METAL 25



METAL
Scocca in Metallo
Metal Body
Métallique



EXTRA LOCK
Serraggio Forte
Double Lock
Blocage Double



AUTO-LOCK
Auto-Bloccaggio
Self-Locking
Autobloquant



SILVER Sk4
Lama Argento
Silver Blade
Lame Argent

25



POWERFUL
Super Robusto
Super Strong
Super Robuste

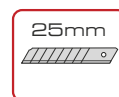

06 193 20
Ricambi - Spare

Art.



06 156 25

25mm



12



156 - BLACK METAL



METAL
Scocca in Metallo
Metal Body
Métallique



EXTRA LOCK
Serraggio Forte
Double Lock
Blocage Double



AUTO-LOCK
Auto-Bloccaggio
Self-Locking
Autobloquant



BLACK Sk2
Lama Nera
Black Blade
Lame Noir

25



POWERFUL
Super Robusto
Super Strong
Super Robuste

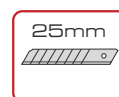

06 193 32
Ricambi - Spare

Art.



06 156 32

25mm



12



143 - SILVER BLACK

18

25



AUTO-LOCK
Auto-Bloccaggio
Self-Locking
Autobloquant



BLACK Sk2
Lama Nera
Black Blade
Lame Noir

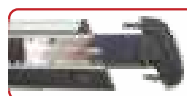

+2 STORE

+2 Lama Include all' Interno
+2 Blades Included Inside
+2 Lames à l' Intérieur



STRONG
Robusto
Strong
Robuste

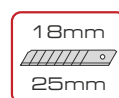

18mm 06 190 32
25mm 06 193 32
Ricambi - Spare

Art.



06 143 18

18mm



12



06 143 25

25mm

12

145 - NINJA

18



SCREW
Cacciavite di Emergenza
Emergency Screwdriver
Tournevis d'Urgence



OPENER
Apri-Latta
Tin-Opener
Ouvre-Bidons



BOX
Apri-Cartoni
Box-Opener
Ouvre-Cartons



AUTO-LOCK
Auto-Bloccaggio
Self-Locking
Autobloquant



BLACK Sk2
Lama Nera
Black Blade
Lame Noir

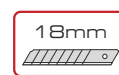

18mm 06 190 32
Ricambi - Spare

Art.



06 145 18

18mm



12



CUTTER

123 - SAFE 18 METAL

18

UTILIZZO ANTINFORTUNISTICO
SAFETY USE
USAGE DE SÉCURITÉ



METAL
Scocca in Metallo
Metal Body
Métallique



SAFE

SAFE
Rientro Automatico
Safety Use
Usage de Sécurité

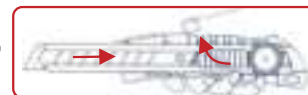

AUTO LOCK

AUTO-LOCK
Auto-Bloccaggio
Self-Locking
Autobloquant



EXTRA SILVER Sk4
Lama Argento
Silver Blade
Lame Argent



STRONG
Robusto
Strong
Robuste

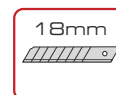

18mm 06 190 10
Ricambi - Spare
06 190 20

Art. 18mm 12 €

125 - SAFE 18

18

UTILIZZO ANTINFORTUNISTICO
SAFETY USE
USAGE DE SÉCURITÉ



SAFE

SAFE
Rientro Automatico
Safety Use
Usage de Sécurité



AUTO LOCK

AUTO-LOCK
Auto-Bloccaggio
Self-Locking
Autobloquant



EXTRA SILVER Sk4
Lama Argento
Silver Blade
Lame Argent



STRONG
Robusto
Strong
Robuste

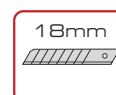

18mm 06 190 10
Ricambi - Spare
06 190 20

Art. 18mm 12 €

149 - SAFE PLUS

TRAPEZ

UTILIZZO ANTINFORTUNISTICO
SAFETY USE
USAGE DE SÉCURITÉ



SAFE PLUS

SAFE PLUS
Rientro Automatico
Safety Use
Usage de Sécurité

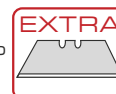

EXTRA SILVER Sk4
Lama Argento
Silver Blade
Lame Argent



SAFE PLUS
Rientro Automatico anche a Pulsante Premuto
Auto Retracting even with Pressed Button
Retour Automatique même à Bouton Enfoncé



LEFT
Mano Sinistra
Left Hand
Main Gauche



RIGHT
Mano Destra
Right Hand
Main Droite

Art. trapez 12 €

129 - SAFE TRAPEZ

TRAPEZ

UTILIZZO ANTINFORTUNISTICO
SAFETY USE
USAGE DE SÉCURITÉ



SAFE

SAFE
Rientro Automatico
Safety Use
Usage de Sécurité



PRO SILVER
Lama Argento
Silver Blade
Lame Argent



METAL
Scocca in Metallo
Metal Body
Métallique

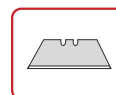

06 191 10
Ricambi - Spares
06 191 20

Art. trapez 12 €

CUTTER

153 - SAFE PLUS METAL

TRAPEZ

UTILIZZO ANTINFORTUNISTICO
SAFETY USE
USAGE DE SÉCURITÉ



SAFE PLUS

SAFE PLUS
Rientro Automatico
Safety Use
Usage de Sécurité

PRO

SILVER
Lama Argento
Silver Blade
Lame Argent



SAFE PLUS
Rientro Automatico anche a Pulsante Premuto
Auto Retracting even with Pressed Button
Retour Automatique même à Bouton Enfoncé



METAL
Scocca in Metallo
Metal Body
Métallique

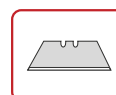

06 191 10
Ricambi - Spares
06 191 20

Art.
06 153 00



trapez



12



122 - GLOBAL SAFE

TRAPEZ

UTILIZZO ANTINFORTUNISTICO
SAFETY USE
USAGE DE SÉCURITÉ



BOX
Apri-Cartoni
Box-Opener
Ouvre-Cartons



STRAP
Taglia-Regge
Strap Cutter
Couple Sangle

SAFE PLUS

SAFE PLUS
Rientro Automatico
Safety Use
Usage de Sécurité

PRO

SILVER
Lama Argento
Silver Blade
Lame Argent



SAFE PLUS
Rientro Automatico anche a Pulsante Premuto
Auto Retracting even with Pressed Button
Retour Automatique même à Bouton Enfoncé



METAL
Scocca in Metallo
Metal Body
Métallique

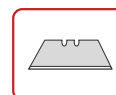

06 191 10
Ricambi - Spares
06 191 20

Art.
06 122 00



trapez



12



120 - PIEGHEVOLE ABS

TRAPEZ



FOLD
Richiudibile
Folding Cutter
Pliant

PRO

SILVER
Lama Argento
Silver Blade
Lame Argent



EASY
Ricambio Facile
Easy Replacement
Rechange Facile

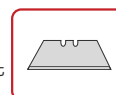

06 191 10
Ricambi - Spares
06 191 20

Art.
06 120 00



trapez



12



121 - PIEGHEVOLE

TRAPEZ



FOLD
Richiudibile
Folding Cutter
Pliant

PRO

SILVER
Lama Argento
Silver Blade
Lame Argent



EASY
Ricambio Facile
Easy Replacement
Rechange Facile

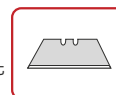

06 191 10
Ricambi - Spares
06 191 20

Art.
06 121 00



trapez



12



CUTTER

128 - BLACK TRAPEZ

TRAPEZ



METAL
Scocca in Metallo
Metal Body
Métallique



EXTRA SILVER Sk4
Lama Argento
Silver Blade
Lame Argent



INCLUDE
+4 Lame
+4 Blades
+4 Lames

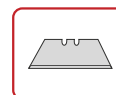

06 191 20
Ricambi - Spares

Art.   €  
06 128 00 trapez 12

130 - METAL TRAPEZ

TRAPEZ



METAL
Scocca in Metallo
Metal Body
Métallique



PRO SILVER
Lama Argento
Silver Blade
Lame Argent

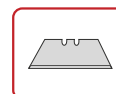

06 191 10
Ricambi - Spares
06 191 20

Art.   €  
06 130 00 trapez 12

152 - GOMMATO TRAPEZ

TRAPEZ



METAL
Scocca in Metallo
Metal Body
Métallique



EXTRA SILVER Sk4
Lama Argento
Silver Blade
Lame Argent



INCLUDE
+5 Lame
+5 Blades
+5 Lames



CABLE
Tagliacavi/Spelafili
Cable Stripper
Coupe Câble / Fil

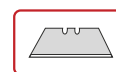

06 191 20
Ricambi - Spare

Art.   €  
06 152 00 trapez 12

155 - GLOBAL USE

TRAPEZ

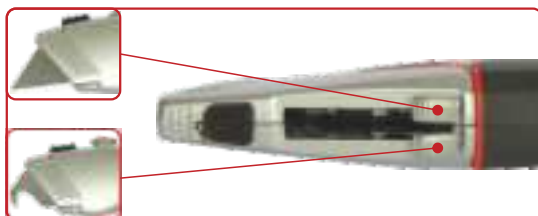

HOOK



EXTRA SILVER Sk4
Lama Argento
Silver Blade
Lame Argent



EXTRA SILVER Sk4
Lama Argento
Silver Blade
Lame Argent



TRAPEZ
+2 Lame
+2 Blades
+2 Lames



HOOK
+2 Lame
+2 Blades
+2 Lames

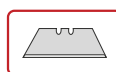

06 191 20
Ricambi - Spare

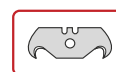

06 192 05
Ricambi - Spare

Art.   €  
06 155 00 hook-trapez 12

Lama Trapezoidale e Uncino nello Stesso Cutter
Trapezoidal and Hook Blade into the Same Cutter
Lames Trapezoidal et Crochet dans le même Cutter

CUTTER

90 18 - TOP SCRAPER

18



POWERFUL
Super Robusto
Super Strong
Super Robuste



METAL
Corpo in Metallo
Metal Body
Métallique

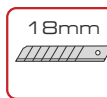

18mm 06 190 10
Ricambi - Spare
06 190 20



HIT
Terminale a Battere
Hammering Ending Cap
Extrémité Martelable



ERGO
Ergonomic
Ergonomic
Ergonomique



ALU HEAD
Alluminio Pressofuso
Die Cast Aluminium
Aluminium Moulé

GRIP
Antiscivolo
Skid-Proof
Anti-Dérapant

DOUBLE SCREW

Extra Tenuta - Ricambio Facile
More Strength - Easy Replacement
Plus de Force - Rechange Facile

Art. €
06 090 18 18mm 5

95 00 - RASCHIETTO METAL

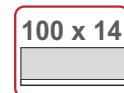

SILVER
Lama Argento
Silver Blade
Lame Argent



GRIP
Antiscivolo
Skid-Proof
Anti-Dérapant

Art. €
06 095 00 100x14 12

95 - RASCHIETTO TRI-COMP

99 - RASCHIETTO BI-COMP

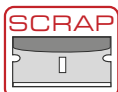

SILVER
Lama Argento
Silver Blade
Lame Argent

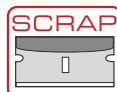

SILVER
Lama Argento
Silver Blade
Lame Argent



Art. €
06 095 50 40x20 12

Art. €
06 099 00 40x20 12

CUTTER

CONFEZIONI - PACKAGING - EMBALLAGE

TUBE

Confezione Standard
Standard Packaging
Emballage Standard

Astuccio Appendibile Riutilizzabile
Resealable Hanging Case
Etui Accrochable Refermable



a Richiesta - on Demand
PERSONALIZZAZIONE 1 Lato
CUSTOMIZATION 1 Side
PERSONNALISATION 1 Face

a Richiesta - on Demand
PERSONALIZZAZIONE 2 Lati
CUSTOMIZATION 2 Sides
PERSONNALISATION 2 Faces

BLACK Sk2 - ULTRA

18



Art.    €
06 190 32 10 20 120

25



Art.    €
06 193 32 10 10 60

SILVER Sk4 - EXTRA

9



Art.    €
06 194 20 10 20 240

18



Art.    €
06 190 20 10 20 120

25

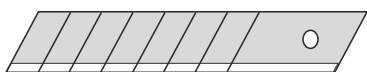

Art.    €
06 193 20 10 10 60

SILVER - PRO

9



Art.    €
06 194 10 10 20 240

18



Art.    €
06 190 10 10 20 120

25

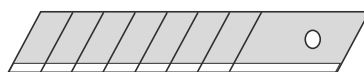

Art.    €
06 193 10 10 10 60

TRAPEZ



Art.    €
06 191 20 10 20 120

TRAPEZ

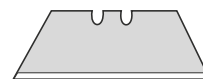

Art.    €
06 191 10 10 20 120

HOOK

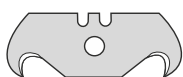

Art.    €
06 192 05 5 10 60

SCRAP

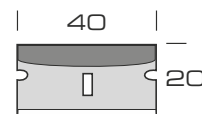

Art.    €
06 196 25 5 10 60

FORBICI - SCISSORS - CISEAUX

CONFEZIONI - PACKAGING - EMBALLAGE



PLASTIC BAG

Confezione Standard
Standard Packaging
Emballage Standard

a Richiesta - on Demand
PERSONALIZZAZIONE Plastic Bag
CUSTOMIZATION Plastic Bag
PERSONNALISATION Plastic Bag



OPTIONAL GREEN
Blister Senza Plastica
Blister Plastic-Free
Blister Sans Plastique

a Richiesta - on Demand
PERSONALIZZAZIONE Plastic Bag
CUSTOMIZATION Plastic Bag
PERSONNALISATION Plastic Bag

06 002 - TITANIUM



STAINLESS STEEL
INOX
TITANIUM COATED
HIGH QUALITY

EXTRA STRONG
3,0 mm
COMFORT GRIP

Art.	mm			€	
06 002 01	210	12	144		
06 002 02	240	12	144		

020 04 - FORBICI BICOM



INOX
MICRO-DENTATA
HIGH QUALITY

MULTI-FUNCTION
COMFORT GRIP

Art.	mm			€	
06 020 04	145	12	144		

06 005 - COUPE



STAINLESS STEEL
INOX
EXTRA STRONG

HIGH QUALITY
2,5 mm
COMFORT GRIP

Art.	mm			€	
06 005 00	210	12	144		

020 02 - FORBICI TOP



INOX
MICRO-DENTATA
HIGH QUALITY

MULTI-FUNCTION
EXTRA STRONG

Art.	mm			€	
06 020 02	145	12	144		

06 007 - NO-STICK



STAINLESS STEEL
INOX
NON-STICK COATED
HIGH QUALITY

NON-STICK
ANTI-ADERENTE
ANTI-ADHESIF

Art.	mm			€	
06 007 00	170	12	144		

020 03 - FORBICI BURN



INOX
MICRO-DENTATA
HIGH QUALITY

MULTI-FUNCTION
ACCIAIO BRUNITO

Art.	mm			€	
06 020 03	145	12	144		

SEGHETTO e VENTOSE - SAW and SUCTION PAD - sCIE ET vENTOUSE

06 301 - DRY-WALL

Seghetto per Cartongesso
Drywall Saw
Scie à Cloison Séche

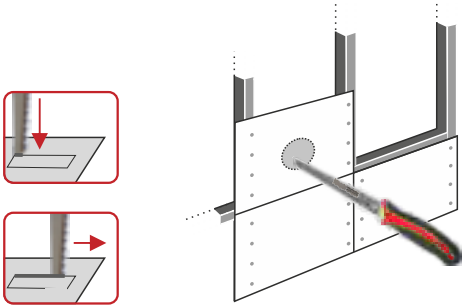

310mm 	 TIP Punta Tagliente Sharp Tip Pointe Tranchante
150mm 	2D CUT Doppia Dentatura Laterale Two Side Toothing Côtés Double Denture
65Mn 1,5mm 	HANDLE Impugnatura Bi-Materiale Bi-Material Handle Poignée Bi-Matière Inserto in Alluminio Aluminum Insert Insert en Aluminium



a Richiesta - on Demand
PERSONALIZZAZIONE Confezione
CUSTOMIZATION Packaging
PERSONNALISATION Emballage



Art.	L	mm			€
06 301 15	310	150	12	72	

15 624 - VENTOSA

Ventosa
Suction Pad
Ventouse



 SUCTION Aspirazione e Rilascio Tramite Leva Quick Suction and Release by Lever Aspiration et Liberation a Levier		Ø 115	50 KG
--	--	--------------	--------------

Art.	Kg	mm			€	
15 624 01	50	115	1	20		B

Ventosa Doppia
Double Suction Pad
Ventouse Double



 SUCTION Aspirazione e Rilascio Tramite Leva Quick Suction and Release by Lever Aspiration et Liberation a Levier		2x Ø 115	100 KG
--	--	-----------------	---------------

Art.	Kg	mm			€	
15 624 02	100	2x 115	1	20		B



a Richiesta - on Demand
PERSONALIZZAZIONE Scatola
CUSTOMIZATION Box
PERSONNALISATION Boite



a Richiesta - on Demand
PERSONALIZZAZIONE Blister
CUSTOMIZATION Blister
PERSONNALISATION Blister

CALIBRI - CALLIPERS - PIED A COULISSE

07 195 - CALLIPER

Acciaio Inox
Stainless Steel
Acier Inoxydable

Bloccaggio a Leva
Locking with Lever
Blocage à Levier



Cromato Opaco
Mat Chromium-Plated
Chromé Mat

Art.	L mm		€
07 195 14	150 0,05	1	

07 191 - DIGIT

Acciaio Inox
Stainless Steel
Acier Inoxydable

Display a Cristalli Liquidi
With Display
Avec Écran



Art.	L mm		€
07 191 15	150 0,01	1	

07 193 - MONOBLOCCO

Monoblocco Acciaio Inox
Stainless Steel Monobloc
Monobloc Acier Inoxydable

Bloccaggio a Leva
Locking with Lever
Blocage à Levier



Scala Cromata Opaca
Mat Chromium-plated
Chromé Mat

Art.	L mm		€
07 193 15	150 0,05	1	
07 193 20	200 0,05	1	

07 192 - OROLOGIO

a Quadrante
Dial Calliper
à Cadran



Acciaio Inox Temperato
Hardened Stainless Steel
Acier Trempé Inoxydable

Art.	L mm		€
07 192 15	150 0,02	1	

07 188 - MONOBLOCCO VITE

Monoblocco Acciaio Inox
Stainless Steel Monobloc
Monobloc Acier Inoxydable

Bloccaggio a Vite
Locking with Screw
Blocage à Vis



Scala Cromata Opaca
Mat Chromium-plated
Chromé Mat

Art.	L mm		€
07 188 15	150 0,05	1	
07 188 20	200 0,05	1	

07 290 - WIDIA TRACER

Tracciatore in Acciaio
Tracer in Steel
Traceur en Acier



Asta Graduata con Guida
Graduated Rod with Guide
Tige Graduéé avec Guide

Art.	L		€
07 290 02	200	1	
07 290 03	300	1	

07 250 - PUNTA

Punta per Tracciare
Scriber
Pointe à Tracer



Acciaio Temperato
Hardened Steel
Acier Trempé

Art.	mm		€
07 250 02	200	10	

07 251 - PENNA

Penna in Alluminio
Engineer's Scriber
Porte Pointe



Punta Widia Carburo Tungsteno
Widia Carbide Tungsten Tip
Pointe Carbure De Tungstène

Art.	mm		€
07 251 01	145	10	
punta di ricambio - spare tip - pointe de rechange			
07 252 00		10	

07 260 - GONIO

Goniometro
Goniometer
Goniomètre



Art.	L		€
07 260 12	120 80	1	
07 260 15	150 120	1	
07 260 20	200 150	1	
07 260 30	320 200	1	

07 261 - SLIDING GONIO

Goniometro
Goniometer
Goniomètre

Asta Scorrevole
Sliding Pole
Axe Coulissant



Art.	L		€
07 261 14	140 120	1	
07 261 30	300 150	1	
07 261 40	400 200	1	

07 280 - PORTACOMP

Portacomparatore Magnetico
Magnetic Dial Gauge Carrier
Porte-comparateur Magnétique



Art.	mm		€
07 280 00	50 x 70 x 65	1	

07 281 - COMPARATORE

Comparatore
Dial Gauge
Comparateur



0,01
Lettura
Reading
Lecture

Art.	min max		€
07 281 00	0 10	1	

SQUADRE - TRY SQUARE - EQUERRE

07 270 - RECTIFIED



Squadra Rettificata
Try Square Rectified
Equerre Rectifiée

Art.	mm		€
07 270 10	100 x 70	6	
07 270 15	150 x 100	6	
07 270 20	200 x 135	6	
07 270 25	250 x 170	6	
07 270 30	300 x 180	6	
07 270 40	400 x 200	6	

07 271 - CAP RECTIFIED



Squadra A Cappello Rettificata
Try Square Cap Type Rectified
Equerre Type Cap Rectifiée

Art.	mm		€
07 271 10	100 x 70	6	
07 271 15	150 x 100	6	
07 271 20	200 x 135	6	
07 271 25	250 x 170	6	
07 271 30	300 x 180	6	
07 271 40	400 x 200	6	

11 077 - SQUADRA

Squadra per Carpentiere
Carpenter's Try Square
Equerre pour Charpentier

Acciaio
Steel
Acier



Pezzo Unico Tagliato a Laser
Single Piece Laser Cut
Une Pièce Coupé au Laser

30x5 mm Sezione
mm Section
mm Section

Art.	cm		€
11 077 04	40	10	
11 077 05	50	10	
11 077 06	60	10	
11 077 08	80	10	
11 077 10	100	10	

11 070 - SQUADRA ECO

Squadra per Falegname
Try Square
Equerre



Art.	cm		€
11 070 25	25	12	
11 070 30	30	12	
11 070 35	35	12	
11 070 40	40	12	

15 267 - PIOMBO

Filo A Piombo
Plumb Bob
Fil À Plomb



Kit Blister
Corda 5m, Pomello e Piastra
5m Cord, Knob and Plate
Corde 5m, Bouton et Plaque



Art.	g		€
15 267 02	200	10	
15 267 03	300	10	
15 267 04	400	10	
15 267 05	500	10	

SQUADRE - TRY SQUARE - EQUERRE

11 075 - 8 IN 1

Squadra Pieghevole
Folding Square
Equerre Pliant

8 Posizioni
Positions
Positions



Alluminio e Acciaio
Aluminium and Steel
Aluminium et Acier

Art.	cm	cm	📏	€
11 075 20	20	8	1	
11 075 30	30	12	1	
11 075 40	40	15	1	

11 080 - MULTI

Squadra Multi-Angoli
Multi-Angles Square
Equerre Multi-Angles



dispositivo graduato con scala di inclinazione 15°
graduated device with inclination scale 15°
dispositif gradué avec gamme d'inclination 15°

Alluminio Anodizzato
Anodized Aluminium
Aluminium Anodisé

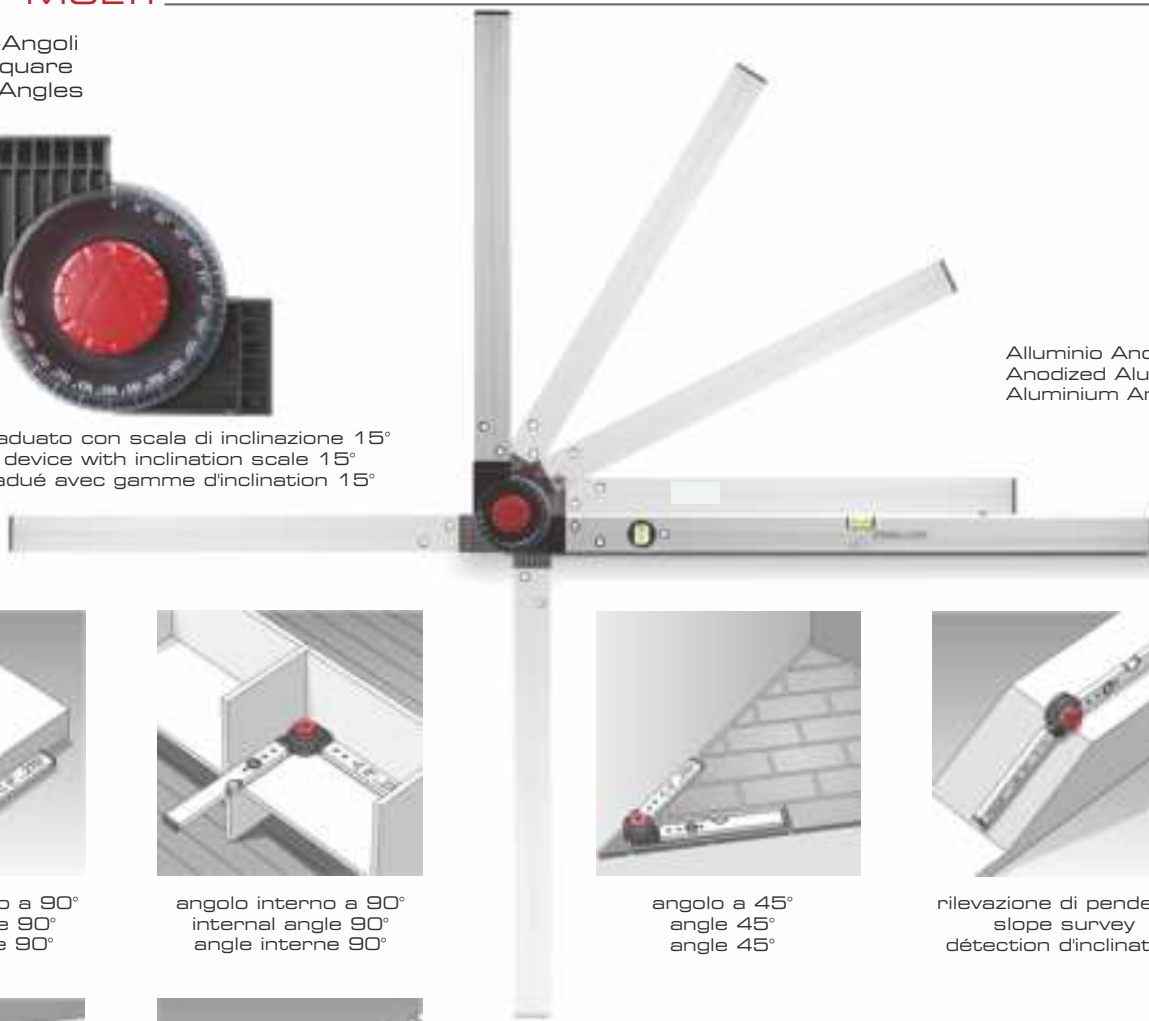

angolo esterno a 90°
external angle 90°
angle externe 90°



angolo interno a 90°
internal angle 90°
angle interne 90°



angolo a 45°
angle 45°
angle 45°

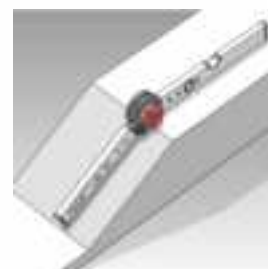

rilevazione di pendenze
slope survey
détection d'inclination



riporto di misurazioni
transfer of measurement
rapport de mesures

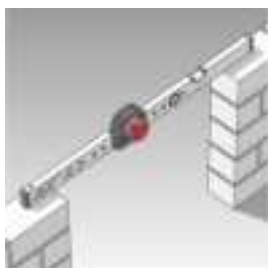

utilizzo come livella
usable as a level
utilisable comme niveau

Riporto o misurazione da 0° a 270°
Angles measurement or report from 0° to 270°
Rapport ou mesure des angles de 0° à 270°

Art.	cm	cm	📏	€
11 080 04	40	30	1	
11 080 08	80	60	1	
11 080 12	120	60	1	

LIVELLE - LEVELS - NIVEAUX

a Richiesta - on Demand
 PERSONALIZZAZIONE Plastic Film
 CUSTOMIZATION Plastic Film
 PERSONNALISATION Plastic Film



10 076 - TOP LEVEL



Art.	cm		€
10 076 04	40	10	
10 076 05	50	10	
10 076 06	60	10	
10 076 08	80	10	
10 076 10	100	10	

10 075 - TOP MAGNETIC



Art.	cm		€
10 075 04	40	10	
10 075 05	50	10	
10 075 06	60	10	
10 075 08	80	10	
10 075 10	100	10	

10 083 - RED LEVEL

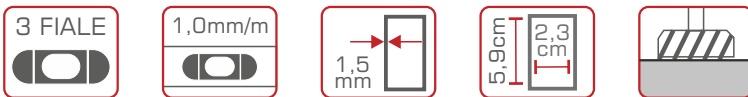

Art.	cm		€
10 083 04	40	10	
10 083 06	60	10	
10 083 08	80	10	

10 079 - RED LEVEL MAG



Art.	cm		€
10 079 04	40	10	
10 079 06	60	10	
10 079 08	80	10	

LIVELLE - LEVELS - NIVEAUX

10 070 - BLACK LEVEL

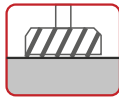
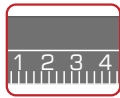
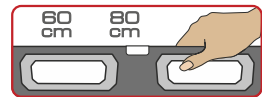
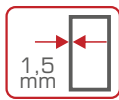

Art.	cm		€
10 070 04	40	10	
10 070 05	50	10	
10 070 06	60	10	

10 071 - BLACK LEVEL MAG



Art.	cm		€
10 071 04	40	10	
10 071 06	60	10	
10 071 08	80	10	

10 061 - SILVER PRO 3

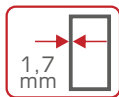

Art.	cm		€
10 061 03	30	10	
10 061 04	40	10	
10 061 05	50	10	
10 061 06	60	10	
10 061 08	80	10	
10 061 10	100	10	

10 060 - SILVER PRO 2

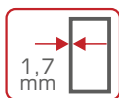
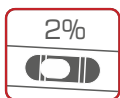

Art.	cm		€
10 060 03	30	10	
10 060 04	40	10	
10 060 05	50	10	
10 060 06	60	10	
10 060 08	80	10	
10 060 10	100	10	

10 085 - SILVER PRO MAG



Art.	cm		€
10 085 04	40	10	
10 085 05	50	10	
10 085 06	60	10	
10 085 08	80	10	
10 085 10	100	10	

LIVELLE - LEVELS - NIVEAUX

10 077 - ECO LEVEL



Art.	cm		€
10 077 04	40	10	
10 077 06	60	10	
10 077 08	80	10	

10 088 - HOBBY



FRONTAL
Lettura Frontale
Frontal View
Lecture Frontale



UPPER
Lettura dall'Alto
Upper View
Lecture d'en Haut



Art.	cm		€
10 088 00	22	25	

10 089 - MINI



10 089 01



10 089 02



FRONTAL
Lettura Frontale
Frontal View
Lecture Frontale



UPPER
Lettura dall'Alto
Upper View
Lecture d'en Haut

Art.	cm		€
10 089 01 ○	10,5	20	
10 089 02 ●	10,5	20	

10 086 - ACQUA



Art.	cm		€
10 086 00	18x3	10	



TUBO

Art.	m		€
10 086 25	25	5	



KIT ACQUA

Art.	m		€
10 086 01	12	5	
10 086 05	25	5	

FILI EDILIZIA - BRICKLAYER WIRE - CORDEAU TRESSE

16 213 - FILO FLUO

Filo Per Edilizia Extra
High Quality Bricklayer Wire
Cordeau Tresse

100m

250m



STRONG
Alta Tenacità
High Toughness
Haute Ténacité



HIGH
Alta Visibilità
High Visibility
Haute Visibilité



FLUO

Giallo Fluo, Alta Visibilità, Riflettente Rosso
Yellow Fluo, High Visibility, Reflective Red
Jaune Fluo, Haute Visibilité, Réfléchissant Rouge

Ø 1,5

Art.	m	Ø		€
16 213 00	100	1,5	15	
16 213 01	250	1,5	15	

Ø 2,5

Art.	m	Ø		€
16 213 02	100	2,5	15	
16 213 03	250	2,5	15	

16 214 - FILO FLUO ORANGE

Filo Per Edilizia Extra
High Quality Bricklayer Wire
Cordeau Tresse

50m

100m

250m



STRONG
Alta Tenacità
High Toughness
Haute Ténacité



HIGH
Alta Visibilità
High Visibility
Haute Visibilité



FLUO

Arancio Fluo, Alta Visibilità, Riflettente Bianco
Orange Fluo, High Visibility, Reflective White
Orange Fluo, Haute Visibilité, Réfléchissant Blanc

Ø 2,5

Art.	m	Ø		€
16 214 02	100	2,5	15	
16 214 03	250	2,5	15	

Ø 3,5

Art.	m	Ø		€
16 214 05	50	3,5	15	
16 214 06	100	3,5	15	

16 215 - FILO FLUO

Filo Per Edilizia Extra
High Quality Bricklayer Wire
Cordeau Tresse

100m

250m



STRONG
Alta Tenacità
High Toughness
Haute Ténacité



HIGH
Alta Visibilità
High Visibility
Haute Visibilité



FLUO

Giallo Fluo, Alta Visibilità, Riflettente Bianco
Yellow Fluo, High Visibility, Reflective White
Jaune Fluo, Haute Visibilité, Réfléchissant Blanc

Ø 1,0

Art.	m	Ø		€
16 215 00	100	1,0	15	
16 215 01	250	1,0	15	

PISTOLE PER SCHIUMA - FOAM GUN - PISTOLET MOUSSE

CONFEZIONI - PACKAGING - EMBALLAGE



Confezione Standard
Standard Packaging
Emballage Standard



a Richiesta - on Demand
PERSONALIZZAZIONE Scatola
CUSTOMIZATION Box
PERSONNALISATION Boite



OPTIONAL
Plastic Bag



a Richiesta - on Demand
PERSONALIZZAZIONE Plastic Bag
CUSTOMIZATION Plastic Bag
PERSONNALISATION Plastic Bag

842 02 - FOAM GUN RED

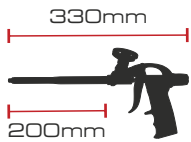

PTFE

Rivestimento Interno Antiaderente
Anti-Adherent Internal Coating
Revêtement Interne Anti-Adhérent



FOAM

Pistola per Schiuma
Foam Gun
Pistolet pour Mousse



CONTROLLER

Regolatore di Flusso
Foam Flow Controller
Reglage du Debit



STRONG

Leggera e Robusta
Light and Strong
Léger et Robuste

Art. 15 842 02 g 250 6 € A

842 03 - FOAM GUN BLACK

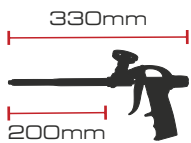

TOTAL PTFE

Rivestimento Interno ed Esterno Antiaderente
Anti-Adherent Internal and External Coating
Revêtement Interne et Externe Anti-Adhérent



FOAM

Pistola per Schiuma
Foam Gun
Pistolet pour Mousse



CONTROLLER

Regolatore di Flusso
Foam Flow Controller
Reglage du Debit



ERGO - GRIP

Ergonomica - Antiscivolo
Ergonomic - Skid-Proof
Ergonomique -Anti-Dérapant

Art. 15 842 03 g 300 6 € A

PISTOLE SILICONE - CAULKING GUN - PISTOLET SILICONE

PERSONALIZZAZIONE - CUSTOMIZATION - PERSONNALISATION

Card



Etichetta



Logo



a Richiesta - on Demand
PERSONALIZZAZIONE Card - Etichetta - Logo
CUSTOMIZATION Card - Label - Logo
PERSONNALISATION Card - Etiquette - Logo

15 843 - ALU GUN



ALU
 Corpo in Alluminio
 Aluminium Body
 Corp en Aluminium



HIGH QUALITY
18:1

400mm

2000N
 forza

Ø 50

310

300

400

600

Art.	L		€
15 843 40	400	6	

250mm

2000N
 forza

Ø 50

310

300

400

Art.	L		€
15 843 25	250	6	

PISTOLE SILICONE - CAULKING GUN - PISTOLET SILICONE

840 10 - BLACK GUN

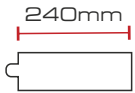

**HIGH QUALITY
18:1**



Silicone - Ancorante Chimico
Silicone - Chemical Anchor
Silicone - Ancrage Chimique



Meccanismo Rinforzato
Reinforced Mechanism
Mécanisme Renforcé



Arresto di Fine Corsa
Automatic Drip Stop
Arret de Fin de Course

Art.	N		€
15 840 10	2000	12	

840 11 - HARDY GUN



**HIGH QUALITY
26:1**



Silicone - Ancorante Chimico
Silicone - Chemical Anchor
Silicone - Ancrage Chimique



Doppio Rinforzo
Doble Reinforcement
Double Renfort



Arresto di Fine Corsa
Automatic Drip Stop
Arret de Fin de Course

Art.	N		€
15 840 11	3600	6	

840 12 - MAXI GUN



**TOP QUALITY
29:1**



Meccanismo di Riduzione dello Sforzo
Effort Reduction Mechanism
Mécanisme de Réduction des Efforts



Silicone - Ancorante Chimico
Silicone - Chemical Anchor
Silicone - Ancrage Chimique

Art.	N		€
15 840 12	29:1	6	

PISTOLE SILICONE - CAULKING GUN - PISTOLET SILICONE

840 02 - CLASSIC GUN



Rinforzo in Metallo
Metal Reinforced
Renfort en Métal



Meccanismo Rinforzato
Reinforced Mechanism
Mécanisme Renforcé

Art.	N		€
15 840 02	1500	24	

840 05 - STRONG GUN

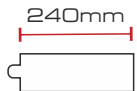

Rinforzo in Metallo
Metal Reinforced
Renfort en Métal



Saldatura a Filo Continuo
Continuous Wire Welding
Soudage à Fil Continu

Art.	N		€
15 840 05	1500	10	

840 04 - SQUELETTE



Leva in Acciaio
Steel Lever
Lever en Acier

Art.	N		€
15 840 04	1200	20	

PISTOLE SILICONE - CAULKING GUN - PISTOLET SILICONE

841- CHEMICAL



**HIGH QUALITY
26:1**



Resina - Ancorante Chimico
Resin - Chemical Anchor
Resine - Ancrage Chimique



Barre di Spinta
Push Bars
Barres de Poussée



Doppio Rinforzo
Doble Reinforcement
Double Renfort

Art.	N		€
15 841 00	3600	6	

841 01- RESINA

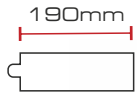

Resina - Ancorante Chimico
Resin - Chemical Anchor
Resine - Ancrage Chimique



Barre di Spinta
Push Bars
Barres de Poussée

Art.	N		€
15 841 01	1800	10	

840 09 - HEAVY GUN



Metallo Fissato a Vite
Screw Fixing Metal
Métal Serré à Vis



Regolazione Pressione
Pressure Adjustment
Réglage de la Pression

Art.	N		€
15 840 09	4000	6	

PISTOLE SILICONE - CAULKING GUN - PISTOLET SILICONE

15 849 - AIR PUMP



STANDARD
con Moschettone
with Carabiner
avec Mousqueton



a Richiesta - on Demand
PERSONALIZZAZIONE Pompa
CUSTOMIZATION Pump
PERSONNALISATION Pompe



OPTIONAL
Plastic Bag

a Richiesta - on Demand
PERSONALIZZAZIONE Plastic Bag
CUSTOMIZATION Plastic Bag
PERSONNALISATION Plastic Bag



AIR
Pompa ad Aria
Air Pump
Pompe Soufflante



CLEAN
Pulizia nelle Operazioni di Fissaggio
Clean Surface in Fastening Operations
Surface Propre Lors des Fixations



WIND
Rimuove Polvere e Detriti dai Fori
Removes Dust and Debris from Holes
Élimine Poussière et Débris des Trous



360° TWIST
Cannuccia Roteante
Rotating Cane
Tube Tournant

Art.
15 849 00

mm
225



24

€



15 850 - SAC A POCHE

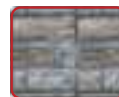

Pavimenti, Muri, Rivestimenti
Floors, Walls, Cladding
Sols, Murs, Revêtements



FIT
Malta, Cemento, Gesso Liquido
Mortar, Cement, Liquid Plaster
Mortier, Ciment, Plâtre Liquide



WASH
Lavabile e Riutilizzabile
Washable and Reusable
Lavable et Réutilisable



NYLON
Punta Rinforzata
Reinforced End
Pointe Renforcé



STUCCATURA e SIGILLATURA
GROUTING and SEALING
JOINTOIEMENT et SCELLEMENT

Art.
15 850 00

mm
520



10

€

FESSURIMETRI - CRACK MONITOR - FISSUROMETRES

PER IL MONITORAGGIO DI CREPE E FESSURE
TO MONITOR CRACKS AND FISSURES
POUR LA SURVEILLANCE DES FISSURES



CONFEZIONI - PACKAGING - EMBALLAGE



Blister Bivalva
Clamshell Blister
Blister Coquille



Scatola
Box
Boîte

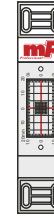
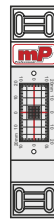

a Richiesta - on Demand
PERSONALIZZAZIONE Blister
CUSTOMIZATION Blister
PERSONNALISATION Blister

a Richiesta - on Demand
PERSONALIZZAZIONE Scatola
CUSTOMIZATION Box
PERSONNALISATION Boîte

a Richiesta - on Demand
PERSONALIZZAZIONE Etichetta
CUSTOMIZATION Label
PERSONNALISATION Etiquette

a Richiesta - on Demand
PERSONALIZZAZIONE Tampografia
CUSTOMIZATION Pad Printing
PERSONNALISATION Tampographie

10 097 - CRACK FLOOR

Fessurimetro per Piani
Crack Monitor for Plans
Fissurometre pour Planes

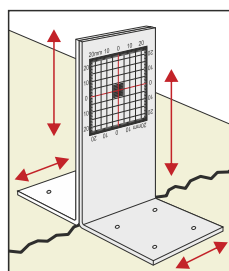
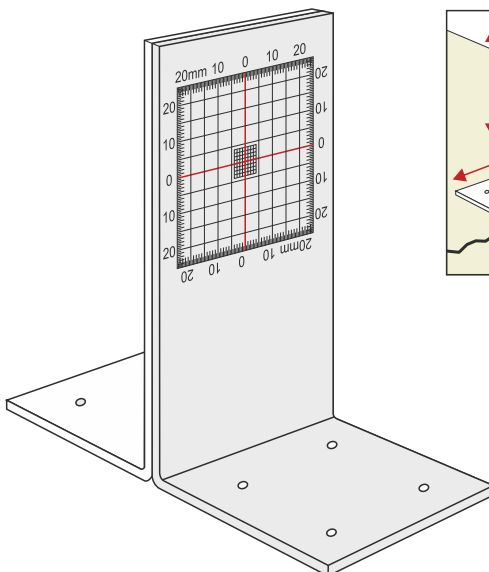

Blister



Il Blister Include:
- Fessurimetro
- Etichette di Posizione
- Tabelle di Rilevazione

Blister Including:
- Crack Monitor
- Labels for Position
- Detection Tables

Le Blister Comprend:
- Fissurometre
- Étiquettes de Position
- Tables de Détection

Art.
10 097 01

n.
1



10

€

FESSURIMETRI - CRACK MONITOR - FISSUROMETRES

10 099 - CRACK WALL

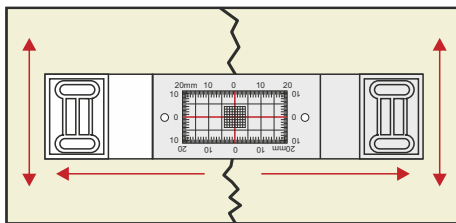
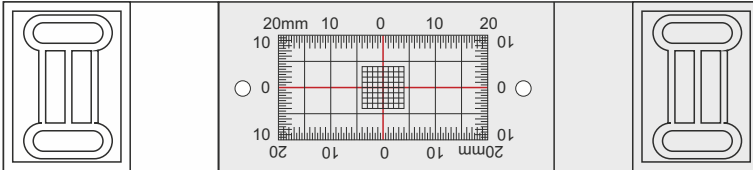
Fessurimetro da Parete
Crack Monitor for Walls
Fissurometre pour Murs



10 099 01 N.1
10 099 02 N.2
10 099 04 N.4



10 099 10 N.10

la Confezione Include:
- Fessurimetro
- PERNI di Allineamento
- Etichette di Posizione
- Tabelle di Rilevazione

Packing Including:
- Crack Monitor
- Alignment Pins
- Labels for Position
- Detection Tables

l'Emballage Comprend:
- Fissurometre
- Broches d'Alignement
- Étiquettes de Position
- Tables de Détection

Art.	n.		€
10 099 01	1	10	
10 099 02	2	10	
10 099 04	4	5	
10 099 10	10	1	

10 098 - CRACK CORNER

Fessurimetro Per Angoli
Crack Monitor For Corners
Fissurometre Pour Coin

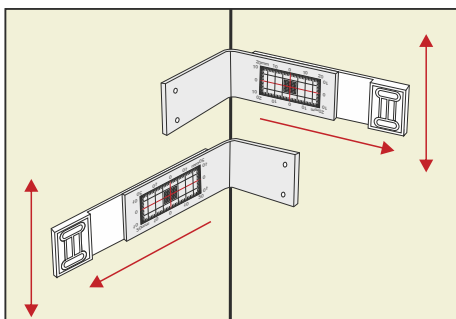
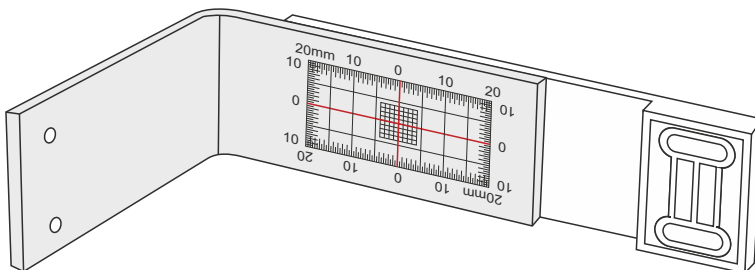

10 098 01 N.1
10 098 02 N.2



10 098 04 N.4

la Confezione Include:
- Fessurimetro
- Etichette di Posizione
- Tabelle di Rilevazione

Packing Including:
- Crack Monitor
- Labels for Position
- Detection Tables

l'Emballage Comprend:
- Fissurometre
- Étiquettes de Position
- Tables de Détection

Art.	n.		€
10 098 01	1	5	
10 098 02	2	5	
10 098 04	4	1	

TRACCIALINEE - CHALK LINE REEL - TRACE LIGNES

CONFEZIONI - PACKAGING - EMBALLAGE

PLASTIC BAG

Confezione Standard
Standard Packaging
Emballage Standard



a Richiesta - on Demand
PERSONALIZZAZIONE Plastic Bag + Etichetta
CUSTOMIZATION Plastic Bag + Label
PERSONNALISATION Plastic Bag + Etiquette

160 01 - ECO REEL

25m



Traccialinee Bicolore
Chalk Line Reel
Trace Lignes

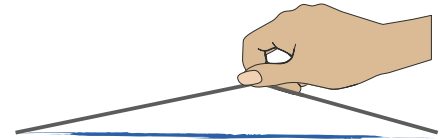

Art.	m		€
12 160 01	25	10	

160 04 - ABS REEL

30m



Traccialinee Bicolore
Chalk Line Reel
Trace Lignes

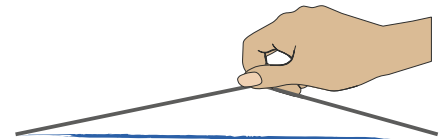

Art.	m		€
12 160 04	30	10	

12 161 - POLVERE

180g

500g



Polvere per Traccialinee
Chalk Line Powder
Poudre à Tracer

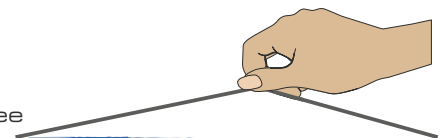

Art.	g		€
12 162 03	180	10	
12 162 05	500	5	

TRACCIALINEE - CHALK LINE REEL - TRACE LIGNES

CONFEZIONI - PACKAGING - EMBALLAGE

PLASTIC BAG

Confezione Standard
Standard Packaging
Emballage Standard



a Richiesta - on Demand
PERSONALIZZAZIONE Plastic Bag + Etichetta
CUSTOMIZATION Plastic Bag + Label
PERSONNALISATION Plastic Bag + Etiquette

B

OPTIONAL
Blister Bivalva
Clamshell Blister
Blister Coquille



a Richiesta - on Demand
PERSONALIZZAZIONE Blister + Etichetta
CUSTOMIZATION Plastic Blister + Label
PERSONNALISATION Blister + Etiquette

163 01 - KIT ECO REEL

Traccialinee + Polvere
Chalk Line Reel + Powder
Trace Lignes + Poudre



KIT 180g

12 162 03



+

25m

12 160 01



Art. g m
12 163 01 ● 180 25

10

€

B

163 04 - KIT REEL

Traccialinee + Polvere
Chalk Line Reel + Powder
Trace Lignes + Poudre



KIT 180g

12 162 03



+

30m

12 160 04



Art. g m
12 163 04 ● 180 30

10

€

B

160 50 - GIANT

30m

Polvere Inclusa
Powder Included
Poudre Incluse

50m

con Impugnatura
with Handle
avec Poignée



400g



400g

Polvere di Ricambio
Spare Powder
Poudre de Rechange

Manovella in Acciaio, Filo ad Alta Resistenza
Steel Crank, High Resistent Thread
Manivelle en Acier, Fil à Haute Résistance

Art.	g	m	☒	☒	€
12 160 30 ●	400	30	3	6	
12 160 50 ●	400	30	3	6	

HQ

Art.	g	☒	☒	€
12 161 34 ●	400	6	12	
12 161 44 ●	400	6	12	

OUTDOOR

14 117 - TRAVEL



Misuratore Stradale
Measuring Wheel
Odometre

2,2kg

1cm

Lettura
Reading
Lecture

Art. m  €
14 117 00 10000 1

14 118 - BICI



Misuratore Stradale
Measuring Wheel
Odometre

2,0kg

10cm

Lettura
Reading
Lecture

Art. m  €
14 118 00 1000 1

15 127 - STAVE



Misuratore Telescopico
Telescopic Levelling Staff
Mètre Télésopique



In Alluminio, 5 Aste, Fronte mm, Retro Geodetica
Aluminium, 5 Poles, mm Front, Geodetic Back
En Aluminium, 5 Brins, Face mm, Anrière Géodésique

Art. cm  €
15 127 00 125-500 1

16 521 - COLONNA

Colonnina con Base in Cemento
Plastic Pillar with Concrete Base
Colonne avec Base en Béton



Art. h  €
16 521 00 90 8

PALINE - POLES - PERCHES

15 121 - FERRO

Palina in Ferro
Iron Ranging Pole
Perche en Fer

15 121 00



Ø 28 mm



Puntale Forgiato
Forged Metal Point
Pointe Forgée

15 122 00



Ø 20 mm



Puntale Forgiato
Forged Metal Point
Pointe Forgée

Ricoperta in Plastica Rossa e Bianca
White and Red Plastic Covered
Recouverte de Plastique Blanc et Rouge

Art.	cm			€
15 121 00	160	10	60	
15 122 00	160	10	50	

15 120 - LEGNO

Palina In Legno
Wood Ranging Pole
Perche En Bois

15 120 01



Ø 28 mm



Puntale Conico
Conic Metal Point
Pointe Conique

15 120 02

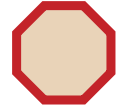

Ø 28 mm



Puntale A Chiodo
Nail Type Point
Pointe Clou

Corpo Verniciato Rosso e Bianco
White and Red Painted Body
Peinte Blanc et Rouge

Art.	cm			€
15 120 01	160	10	60	
15 120 02	160	10	60	

15 123 - 2 PEZZI

Palina in Ferro
Iron Ranging Pole
Perche en Fer



2 pcs

15 123 00



Ø 20 mm



Puntale Conico
Conic Metal Point
Pointe Conique

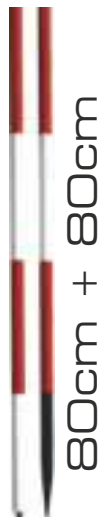

Ricoperta in Plastica Rossa e Bianca
White and Red Plastic Covered
Recouverte de Plastique Blanc et Rouge

Art.	cm			€
15 123 00	80+80	10	20	

16 522 - PICCHETTO

Picchetto in Ferro
Iron Peg
Piquet en Fer



16 522 00



Ø 20 mm



Puntale Conico
Conic Metal Point
Pointe Conique



Per Catene Pvc o Ferro
For Pvc and Iron Chains
Pour Chaînes Pvc ou Fer

Ideale per delimitare Giardini,
Campi Sportivi e Aree Varie
Recommended to define Gardens,
Sports Fields and Various Areas
Pour délimiter Jardins, Terrains
de Sport et les Divers Secteurs

Art.	cm			€
16 522 00	160	10	50	

BORSE - BAGS - BOURSE

22 561 - BIG BAG

Borsa Porta Attrezzi
Tool Bag
Boîtes À Outils



HIGH
Alta Resistenza
High Resistant
Haute Résistance



TECH
Tessuto Tecnico
Technical Material
Matériel Technique



STRONG
con Maniglia
with Handle
avec Poignée



STRAP
con Tracolla
Shoulder Strap
Bandouliere



MULTI
Multi Vani Porta Utensili
Multi Compartments
Multi Compartiments



Art.
22 561 00



2



6



15 465 - TECH 24 ORE

Borsa Porta-Utensili
Nylon Tool-Bag
Bourse Porte-Outils

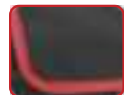

TECH
Tessuto Tecnico
Technical Material
Matériel Technique



Con Maniglia, Chiusura a Cerniera
With Handle, Zip Closing
Avec Poignée, Fermeture Éclair



Art.
15 465 00



10



15 455 - TOOL BAG

Porta-Utensili
Tool-Bag
Porte-Outils

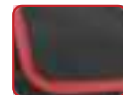

TECH
Tessuto Tecnico
Technical Material
Matériel Technique



cintura non inclusa
without belt
sans ceinture

Art.
15 455 00



10



BORSE - BAGS - BOURSE

15 456 - TECH BAG



HIGH
Alta Resistenza
High Resistant
Haute Résistance



MULTI
Multi Vani Porta Utensili
Multi Compartments
Multi Compartiments



TECH
Tessuto Tecnico
Technical Material
Matériel Technique



BELT
Cintura Inclusa
Belt Included
Avec Ceinture

Art.
15 456 00



5

€

15 459 - NYLON BAG



Nylon

cintura inclusa
belt included
avec ceinture

Art.
15 459 00



15

€

15 458 - MULTI-TASCA



Pelle Morbida
Soft Leather
Peau Velouté

cintura inclusa
belt included
avec ceinture

Art.
15 458 00



5

€

454 10 - PORTATENAGLIE



Porta Tenaglio e Porta Filo di Ferro
Pincer Holder and Wire Holder
Porte Tenaille et Porte Fil



TECH
Tessuto Tecnico
Technical Material
Matériel Technique

Art.
15 454 10



10

€

454 20 - PORTAMARTELLO



Porta Martello e Flessometro
Hammer Holder and Tape Holder
Porte Marteau et Porte Mètre



TECH
Tessuto Tecnico
Technical Material
Matériel Technique

Art.
15 454 20



10

€

15 450 - CINTURE



15 450 01
Pelle
Leather
Cuir



15 450 02
Cuoio
Leather
Cuir



15 450 03
Nylon

Art.

cm



€

15 450 01

145

5

15 450 02

145

15

15 450 03

145

20

SPAZZOLONI - BROOMS - BALAIS

23 130 - CANTIERE ORO _____



HOT SURFACE

Setole Resistenti al Calore
Heat Resistant Bristles
Résiste à la Chaleur

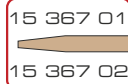

STABLE

Aggancio Stabile
Highly Stable
Haute Stabilité



Setole Rigide Anti-Usura
Wear-Proof Stiff Bristles
Poils Rigides Anti Usure



STRONG

Alta Resistenza
Highly Resistant
Haute Qualité

Art.	cm		€
23 130 40	40	6	
23 130 60	60	6	
23 130 80	80	6	

23 137 - CANTIERE PIUMA _____



PIUMA

Setole Piumate
Feathered Bristles
Poils à Plumes

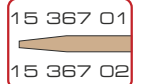

STABLE

Aggancio Stabile
Highly Stable
Haute Stabilité



Setole Piumate Anti-Abrasion
Abrasion-Proof Stiff Bristles
Poils Rigides Anti Abrasion



STRONG

Alta Resistenza
Highly Resistant
Haute Qualité

Art.	cm		€
23 137 40	40	6	
23 137 60	60	6	
23 137 80	80	6	

23 138 - CANTIERE BLACK _____

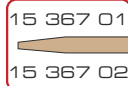

Art.	cm		€
23 138 40	40	6	
23 138 60	60	6	
23 138 80	80	6	

15 625 - SPINGIACQUA _____

Spatolone Spingiacqua
Squeegee
Raclette

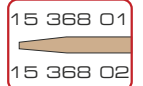

Doppia Gomma
Double Rubber
Double Mousse

Art.	cm		€
15 625 45	45	6	
15 625 55	55	6	
15 625 75	75	6	

16 390 - RASCHIAFANGO _____

Raschiafango in Lamiera
Metal Sheet Mud-Rasp
Rabot à Boue en Tôle



Art.	cm		€
16 390 40	40	12	

16 385 - ASFALTO _____

Stendiasfalto
Asphalt Spreader
Racloir à Bitume

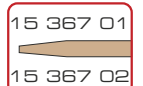

Art.	cm		€
16 385 50	50	5	

BADILI - SHOVELS - PELLES

15 386 - GOLD

Acciaio Temperato "Oro"
Hardened Steel "Gold"
Acier Trempé "Or"

15 360 01
15 360 12



Art. €
15 386 00 12
manicato - handle - manche 15 386 01 6

15 381 - BLUE

Acciaio Temperato
Hardened Steel
Acier Trempé

15 360 01
15 360 12



Art. €
15 381 00 12
manicato - handle - manche 15 381 01 6

15 382 - LIGHT

Lega Leggera d'Alluminio
Light Alloy Aluminium
Alliage Léger d'Aluminium

15 360 03



Manico in Pioppo Leggero
Light Poplar Handle
Manche en Peuplier Léger

Art. €
15 382 01 6
manicato - handle - manche

15 384 - CARBONE

24x30 Zincata
24x30 Zinc Plated
24x30 Galvanisé

15 360 01
15 360 12



Art. €
15 384 00 12
manicato - handle - manche 15 384 01 6

16 380 - MALTA

Stendimalta
Mortar Spreader
Épandeur

15 367 01
15 367 02

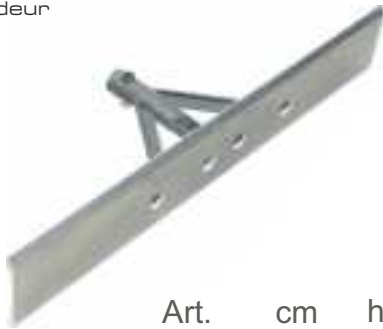

Art. cm h €
16 380 60 60 10 3

16 379 - STENDIMALTA

Lega di Alluminio
Aluminium Alloy
Alliage d'Aluminium

15 367 01
15 367 02

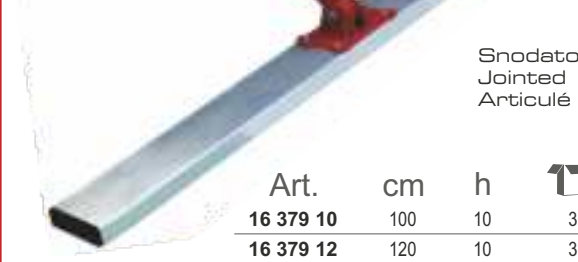

Snodato
Jointed
Articulé

Art. cm h €
16 379 10 100 10 3
16 379 12 120 10 3
16 379 15 150 10 3

23 100 - RASTRELLI

Lega Leggera d'Alluminio
Light Alloy Aluminium
Alliage Léger d'Aluminium

15 367 01
15 367 02

Rinforzato
Reinforced
Renforcé

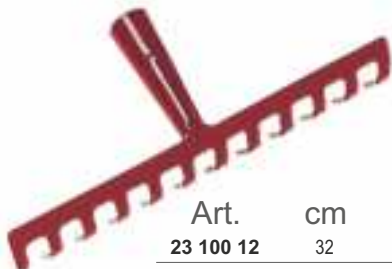

Art. cm d €
23 100 12 32 12 12
23 100 16 43 16 12
23 100 20 54 20 12

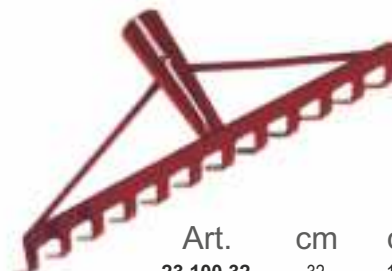

Art. cm d €
23 100 32 32 12 12
23 100 43 43 16 12
23 100 54 54 20 12

SCOPE - BROOMS - BALAIS

23 131 - INDUSTRIAL

Scopa Industriale
Industrial Broom
Balai Industriel



Art. cm €
23 131 00 30 10

15 368 01

15 368 02

Setole Piumate
Feathered Bristles
Poils à Plumes



Art. cm €
23 131 10 30 10

23 132 - INTERNI

Scopa per Interni
Indoor Broom
Balai d'Interne



Art. cm €
23 133 00 30 10

15 368 01

15 368 02

Bi-Colore
Bi-Color
Bi-Couleur



Art. cm €
23 132 00 30 10

23 134 - FIBRA ALTA

Scopa in Fibra per Interni
Indoor Fiber Broom
Balai d'Interne en Fibre



Art. cm €
23 134 00 30 10

15 368 01

15 368 02

Versione Extra Alta
Extra High Version
Version Haute Plus



Art. cm €
23 134 10 30 10

23 150 - PALETTE



Paletta Alza-immondizia
Dust Shovel
Pelle pour Balayage



METAL
Metallo Zincato
Metal Body
Métallique

Art. €
23 150 00 12



PPL Pieghevole
Folding PPL
PPL Pliant



Art. €
23 150 10 12

PALE DA NEVE - SNOW SHOVEL - NEIGE

15 372 - ICE SCRAPER



Raschietto Parabrezza
Windscreen Scraper
Grattoir à Glace



Art.
15 377 01

50 €



con Spazzola
with Brush
avec Brosse

Art.
15 377 02

30 €

15 377 - NEVE ALU

Lega d'Alluminio
Aluminium Alloy
Alliage d'Aluminium

800g

Spessore 2mm
Thickness 2mm
Épaisseur 2mm



Art.
15 377 01

800 €



Art.
15 377 02

1000 €

1000g

Spessore 2,5mm
Thickness 2,5mm
Épaisseur 2,5mm

15 378 - NEVE FIBER



33x48

PPL Rinforzato Fibra
Fiber Reinforced PPL
PPL Renforcé Fibre

Art.
15 378 01

33x48 €



34x55

Versione Capiente
Large Version
Version Grande

Art.
15 378 02

34x55 €

15 379 - NEVE PPL

PPL

45x38

Pala e Spingineve
Snow Pusher Shovel
Pelle et Pousse-Neige



Art.
15 379 00

45x38 €



Art.
15 379 02

45x38 €

45x38

con Profilo Rinforzato
Reinforced Profile
avec Profil Renforcé

15 360 - MANICI NEVE

Faggio
Beech
Hêtre

140cm



Art.
15 360 01

140 €

Pioppo
Poplar
Peuplier

140cm



STRONG
Leggero e Robusto
Light and Strong
Léger et Robuste

Art.
15 360 03

140 €

SPATOLE - SPATULAS - SPATULES

15 099 - SPATOLA _____



Art.	mm		€
15 099 03	30	12	
15 099 04	40	12	
15 099 05	50	12	
15 099 06	60	12	
15 099 07	70	12	
15 099 08	80	12	
15 099 10	100	12	
15 099 12	120	12	

15 093 - SPATOLA INOX _____



Art.	mm		€
15 093 04	40	12	
15 093 06	60	12	
15 093 08	80	12	
15 093 10	100	12	
15 093 12	120	12	
15 093 15	150	12	

15 085 - SOFT TOUCH _____



Art.	mm		€
15 085 03	30	12	
15 085 04	40	12	
15 085 05	50	12	
15 085 06	60	12	
15 085 07	70	12	
15 085 08	80	12	
15 085 10	100	12	

15 087 - SOFT TOUCH INOX _____



Art.	mm		€
15 087 05	50	12	
15 087 07	75	12	
15 087 10	100	12	

15 075 - MULTI-SCRAPER _____

Raschiatore Multifunzione, Lama con Affilatura
Multi-Functions Scraper, Sharpened Blade
Grattoir Multi-Fonctions, Lame Aiguisée



Rimuovi-Stucco, Pulizia Crepe, Apri-Latta, Apri-Cartucce
Remove-Putty, Crack Cleaner, Can and Cartridge Opener
Couteau à Mastic, Nettoyeur de Fissures, Ouvre Boite

Art.	mm		€
15 075 00	65	12	

15 510 - INTONACO _____

Raschiatore per Intonaco
Plastering Scraper
Platoir Grattoir

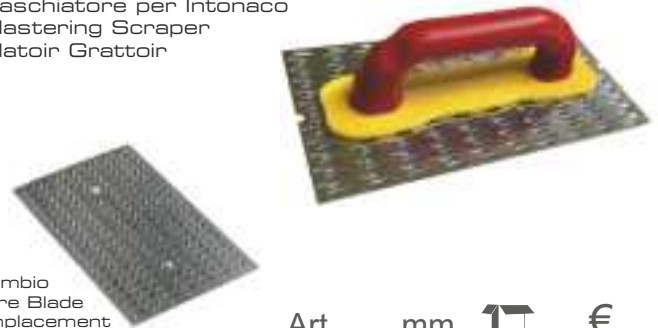

Ricambio
Spare Blade
Remplacement

Art.	mm		€
15 510 00	25 x 15	12	
15 510 10	ricambio	6	

15 509 - RABOT _____

8 Lame Pressofuse
8 Die-Cast Blades
8 Lames Moulé

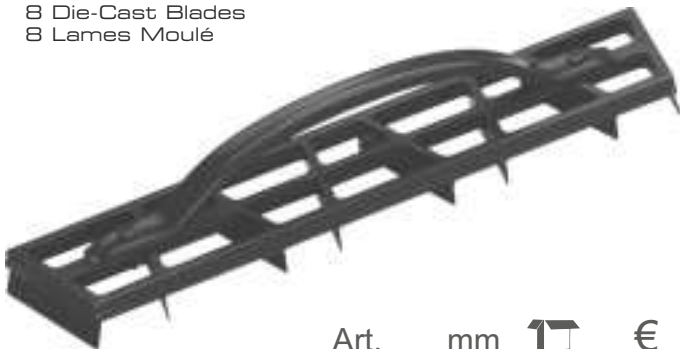

Art.	mm		€
15 509 00	46 x 9	6	

15 508 - RASATORE _____

7 Lame Temprate
7 Hardened Blades
7 Lames Trempé



Art.	mm		€
15 508 00	27 x 12	6	

RASCHIATORI - SCRAPER - GRATTOIR

15 070 - SCRAPER



ERGO
Manico Economico
Ergonomic Handle
Manche Ergonomique

10cm

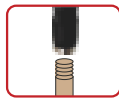

READY
Filetto per Manici
Thread for Handles
Filetage pour Manche



STEEL
Acciaio Temprato
Hardened Steel
Acier Trempé

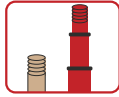

Art.	L		€
15 070 10	10	12	

HANDLE VERSION



DOUBLE ERGO
Impugnatura Egonomiche
Ergonomic Handles
Poignée Ergonomique



150cm



Art.	L		€
15 070 15	150	12	

15 072 - SLOPED SCRAPER



ERGO
Manico Economico
Ergonomic Handle
Manche Ergonomique

10cm

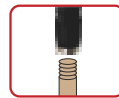

READY
Filetto per Manici
Thread for Handles
Filetage pour Manche



STEEL
Acciaio Temprato
Hardened Steel
Acier Trempé



Art.	L		€
15 072 10	10	12	

HANDLE VERSION



DOUBLE ERGO
Impugnatura Egonomiche
Ergonomic Handles
Poignée Ergonomique



150cm



Art.	L		€
15 072 15	150	12	

15 078 - BLUE SCRAPER



LAMA
Acciaio Blu Temprato
Blue Hardened Steel
Acier Blue Trempé



BODY
Acciaio Zincato
Zinc Plated Steel
Acier Zingué



15 367 01
15 367 02

Art.	L		€
15 078 10	10	12	
15 078 15	15	12	
15 078 20	20	12	

15 080 - HARD SCRAPER

Raschietto Acciaio Temprato
Hardened Steel Scraper
Grattoir Acier Trempé



150cm

Art.	cm		€
15 080 15	15x15	6	
15 080 35	35x35	6	

ARCHETTI - HACKSAW - SCIE

15 826 - IMPOSSIBLE



Regolazione a 45°
45° adjustable blade
Lame réglable à 45°

Vano lame di scorta
blades compartment
Espace porte-lames

Per Tagli Impossibili
For Impossible Cuts
Coupes Impossibles



Art. cm  €
15 826 00 30 12

15 824 - 8 POSIZIONI



Pratico Tendilama
Blade Tensioning
Système de Tension

8 posizioni di taglio
8 cutting positions
8 positions de coupe



Art. cm  €
15 824 00 30 12

15 821 - ARCHETTO



Impugnatura Antiurto
Shock-Proof Handle
Poignée Anti-Chocs

Art. cm  €
15 821 00 30 12

15 827 - MINI



15 827 00



15 828 00

Art. cm  €
15 827 00 15 12
15 828 00 15 12

15 823 - MANICO LEGNO



Acciaio Laminato A Freddo
Cold Rolled Steel
Acier Laminé À Froid

Art. cm  €
15 823 00 30 12

15 822 - TUBOLARE



Tubolare
Tubular
Tubulaire

Art. cm  €
15 822 00 30 12

15 822 - LAME

Bi-metallica
Bi-metal
Bi-métal



Art. cm  €
15 822 03 30 100

MISCELATORI - MIXERS - MALAXEURS

15 830 - MIXER

Miscelatore Professionale
Professional Mixing Paddle
Malaxeurs Professionnel

15 830 02
Doppia Elica
Twin Screw
Double Hélice

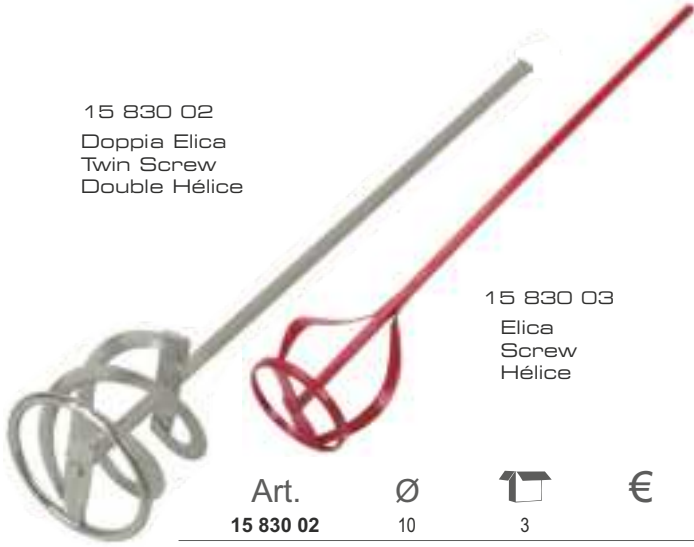

15 830 03
Elica
Screw
Hélice

Art.	Ø		€
15 830 02	10	3	
15 830 03	10	3	

15 831 - MIXER M14

Miscelatore Professionale M14
M14 Professional Mixing Paddle
Malaxeurs Professionnel M14

Doppia Elica
Twin Screw
Double Hélice

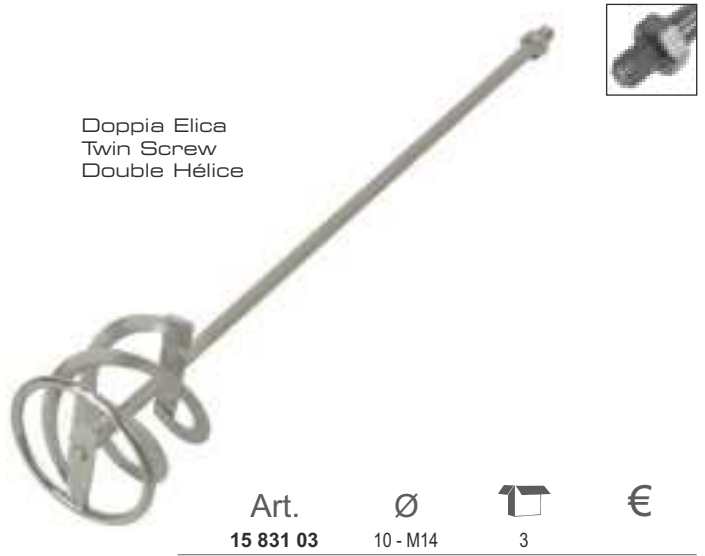

Art.	Ø		€
15 831 03	10 - M14	3	

Frusta
Whip
Fouet

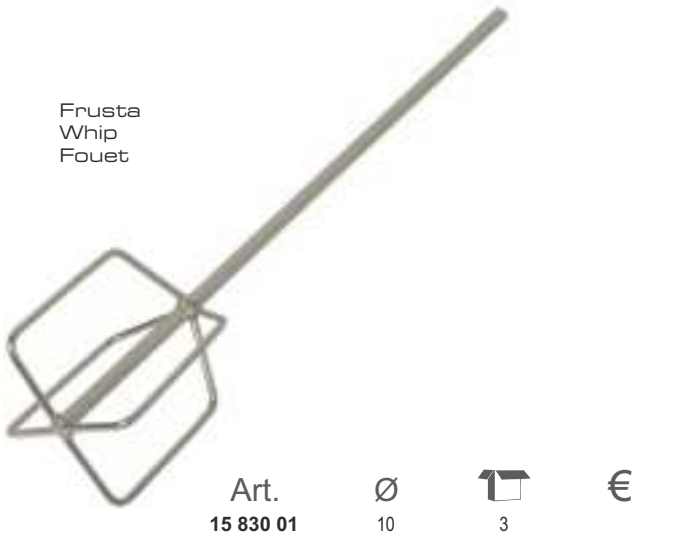

Art.	Ø		€
15 830 01	10	3	

Frusta
Whip
Fouet

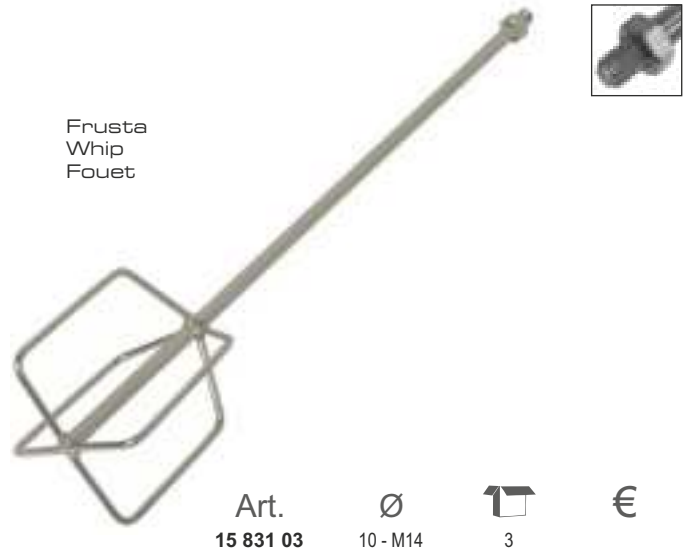

Art.	Ø		€
15 831 03	10 - M14	3	

Frusta Aperta
Open Whip
Fouet Ouverte

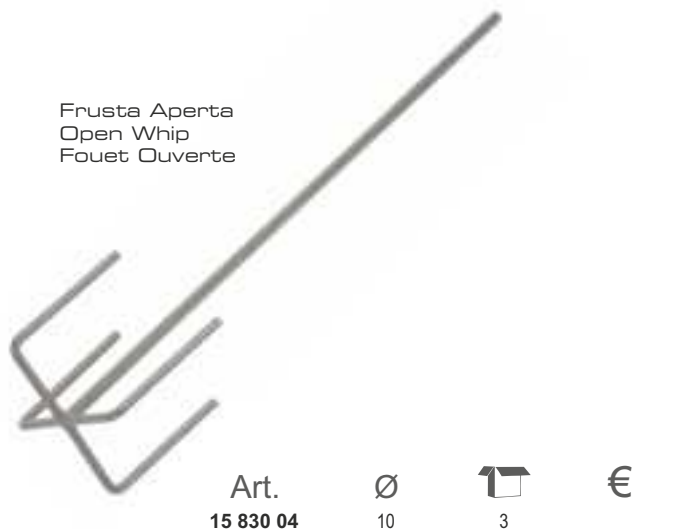

Art.	Ø		€
15 830 04	10	3	

Frusta Aperta
Open Whip
Fouet Ouverte

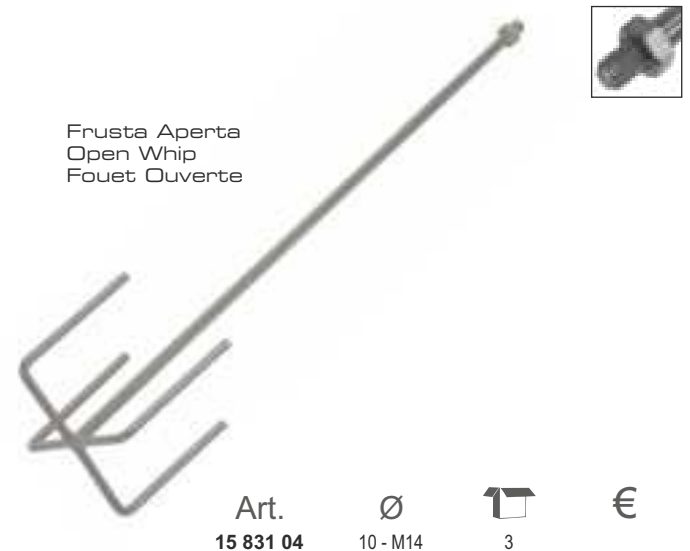

Art.	Ø		€
15 831 04	10 - M14	3	

SCALPELLI - CHISELS - BURIN

15 400 - SALVAMANO

Salvamano
Hand Protector
Protège-Mains



Art.	mm	Ø		€
15 400 16		16	12	

15 439 - MATTONI

Riaffilabile
Regrindable
Affutable



Art.	mm	T		€
15 439 50	230	50	6	
15 439 70	230	70	6	

15 426 - FORGIATO

Acciaio Forgiato
Hardned Steel
Acier Forgé



Art.	mm	Ø		€	
15 426 25	250	16	6		
15 426 30	300	16	6		
15 426 35	350	16	6		



Art.	mm	Ø		€	
15 427 25	250	16	6		
15 427 30	300	16	6		
15 427 35	350	16	6		

15 428 - RIAFFILABILE 16

Riaffilabile
Regrindable
Affutable



Art.	mm	Ø		€
15 428 25	250	16	6	
15 428 30	300	16	6	
15 428 35	350	16	6	
15 428 40	400	16	6	



Art.	mm	Ø		€
15 429 25	250	16	6	
15 429 30	300	16	6	
15 429 35	350	16	6	
15 429 40	400	16	6	

15 436 - RIAFFILABILE 10

Riaffilabile
Regrindable
Affutable



Art.	mm	Ø		€
15 436 20	200	10	6	
15 436 25	250	10	6	
15 436 30	300	10	6	



Art.	mm	Ø		€
15 437 20	200	10	6	
15 437 25	250	10	6	
15 437 30	300	10	6	

LEVE e PIASTRE - LEVER and BENDER - LEVIER et CINTREUSE

22 470 - SPAZZOLE

Spazzole Acciaio
Steel Wire Brush
Brosse Métallique



Art.		€
22 470 00	12	
22 470 02	12	
22 470 03	12	

16 200 - FIL DI FERRO

Filo di Ferro Cotto, Bianco, 0,33kg
Iron Wire, White, 0,33kg
Fil de Fer, Blanc, 0,33kg



Art.	ø	n	€
16 200 09	1	5 75	

15 813 - TENAGLIE

Chrome Vanadium



Art.	cm	€
15 813 22	22	
15 813 25	25	

15 211 - PIEGAFERRO EXTRA

Piastra Piegaferro Extra
Iron Bar Bender Extra
Cintreuse à Couder Extra



5,7kg

Art.	ø	cm	€
15 211 24	24	13x20	

15 432 - PEG

Fermastadia
Mason's Peg
Chevillette



Art.	mm	€
15 432 25	250	

15 433 - PEG EXTRA

Forgiata, Riaffilabile
Forged, Re-grindable
Forgé, Affutable



EXTRA



Art.	mm	€
15 433 25	300	

15 421 - LEVACHIODI

Levachiodi
Nail Puller Bar
Extracteur de Pointes



Art.	cm	€
15 421 05	50	
15 421 06	60	
15 421 07	70	
15 421 08	80	
15 421 10	100	

15 420 - LEVA

Leva in Acciaio
Steel Lever
Levier en Acier

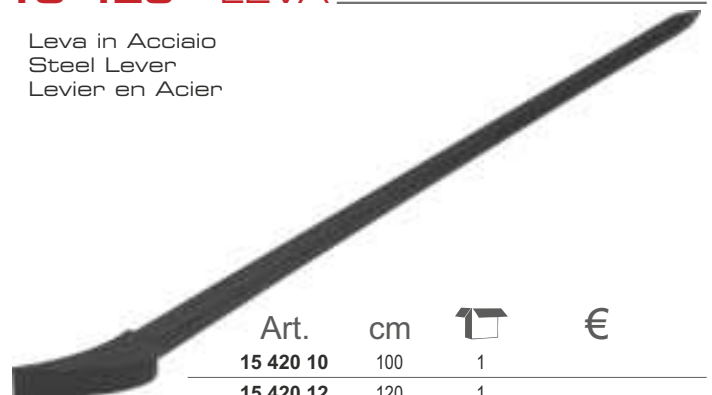

Art.	cm	€
15 420 10	100	
15 420 12	120	
15 420 14	140	

MARTELLI - HAMMERS - MARTEAUX

15 401 - CARPENTIERE

CARPENTIERE - con Calamita
 CARPENTER - with Magnet
 MENUISIER - Magnétique

SINTEX



Art.	g		€
15 401 25	250	12	
15 401 30	300	12	
15 401 40	400	12	



Art.	g		€
15 411 25	250	12	
15 411 30	300	12	
15 411 40	400	12	

15 402 - MAZZETTA

MAZZETTA - Antisfilamento
 BLACKSMITH - Mason
 MASSETTE - Maçon

SINTEX



Art.	g		€
15 402 18	800	12	
15 402 20	1000	12	
15 402 22	1200	12	



Art.	g		€
15 412 18	800	12	
15 412 20	1000	12	
15 412 22	1200	12	

15 405 - DA BANCO

MARTELLINO - alla Tedesca
 HAMMER - German type
 MARTEAU - type Allemand

SINTEX



Art.	g		€
15 405 20	200	12	
15 405 30	300	12	
15 405 40	400	12	
15 405 50	500	12	
15 405 60	600	12	
15 405 80	800	12	
15 405 00	1000	12	



Art.	g		€
15 415 20	200	12	
15 415 30	300	12	
15 415 40	400	12	
15 415 50	500	12	
15 415 60	600	12	
15 415 80	800	12	
15 415 00	1000	12	

15 403 - MARTELLINA

MARTELLINA - Malepeggio
 PICK HAMMER
 PIOLET

SINTEX



MARTELLINA - Catania
 PICK HAMMER
 PIOLET



Art.	g		€
15 403 14	400	12	
15 403 34	400	12	



Art.	g		€
15 413 14	400	12	
15 413 34	400	12	

MARTELLI - HAMMERS - MARTEAUX

15 417 - PICCONE

PICCONE - Occhio Ovale
 PICKAXE - Oval Eye
 PIOCHE - Oeil Oval



Art. 15 417 11 g 1500  6 €

SINTEX



Art. 15 417 21 g 1500  6 €

15 404 - ACCETTA

ACCETTA - antisfilamento
 HATCHET - hammer head
 HACHETTE - a marteau



Art. 15 404 70 g 700  12 €

SINTEX



Art. 15 414 70 g 700  12 €

15 406 - PICOZZINO

PICOZZINO - carpentiere
 HATCHET - charpenter
 HACHETTE - charpentier



Art. 15 406 60 g 600  12 €

SINTEX





Art. 15 416 60 g 600  12 €

16 806 - GOMMA BIANCA

MAZZUOLA - Gomma Bianca Extra
 MALLET - White Rubber Extra
 MAILLET - Caoutchouc Blanche





Art. 16 806 05 g 500  12 €
 Art. 16 806 10 g 1000  12 €

15 600 - SECCHIO

Secchio
 Pail
 Seau

Secchio - Extra
 Pail - Extra
 Seau - Extra



Art. 15 600 36 Ø 36  10 €
 Art. 15 601 36 Ø 36  10 €

MANICI - HANDLES - MANCHES

15 360 - MANICI



Art.	cm		€
15 360 01	140	25	
15 360 12	140	12	



Art.	cm		€
15 360 03	140	25	



Art.	cm		€
15 360 05	140	25	



Art.	cm		€
15 361 01	90	25	
15 361 12	90	12	



Art.	cm		€
15 362 01	90	25	
15 362 12	90	12	



Art.	cm		€
15 363 05	27	25	
15 363 11	27	12	



Art.	cm		€
15 364 01	40	25	
15 364 11	40	12	



Art.	cm		€
15 365 01	50	25	
15 365 11	50	12	

ASTE TELESCOPICHE - HANDLES - MANCHES

15 360 - MANICI



Art.	cm		€
15 367 01	150	25	
15 367 02	180	25	



Art.	cm		€
15 368 01	130	25	
15 368 02	130	25	

23 307 - ASTA

Asta Telescopica
Telescopic Handle
Manche Télescopique



Art.	m		€
23 307 02	2	20	
23 307 03	3	12	

23 308 - ASTA ALU

Asta Telescopica
Telescopic Handle
Manche Télescopique



Art.	m		€
23 308 45	4,5	1	
23 308 60	6	1	
23 308 80	8	1	
23 308 90	9	1	

15 393 - RATCHET

a Cricchetto, Rivestita
Ratchet Spanner, Coated
Cliquet Réversible, Recouvert



21/22



Art.				€
15 393 00	21/22	3	12	

a Cricchetto
Ratchet Spanner
Cliquet Réversible



21/22



Art.				€
15 393 01	21/22	6	12	

15 394 - CHIAVE

Cromo Vanadio
Chrome Vanadium
Chrome Vanadium

21/22



Art.				€
15 394 00	21/22	5	10	

15 399 - MORSETTO

Morsetto Messa a Terra
Grounding Clamp
Pince de Terre



Art.	tipo			€
15 399 00	zinc.	10	30	

15 395 - TAPPO

Tappo Protezione
Safety End Cap
Embout de Sécurité

6 / 20



Ø / 48

Art.	Ø		€
15 395 19	6 / 20	200	
15 395 48	48	100	

15 398 - BASE

Sottobasetta
Base Plate
Plaque de Base



Art.	mm		€
15 398 00	200	50	

15 396 - GIUNTO

Coprigiunto
Joint Cover
Couvre-Joint



Art.		€
15 396 01	50	
15 396 02		50

15 397 - TUBO

Copritubo
Tube Sleeve Protector
Couvre-Tube



Art.	mm		€
15 397 01	200	30	

PONTEGGIO - SCAFFOLD - ECHAFAUD

15 391 - CORDINO Cert. 082608A

Cordino di Sicurezza
Safety Wire
Fil de Sécurité



Art. ☐ ☑ €
15 391 50 3 12

15 392 - KEYCHAIN Cert. 082608A

Porta Chiavi da Ponteggio
Spanner Keychain
Porte Clés de Echafaud



Art. ☐ ☑ €
15 392 00 3 12

16 031 - PONTEGGIO

Elmetto Ponteggiatore
Scaffolding Helmet
Casque d'Echafaudage

UNI-EN 397
-20° + 50°
size 53 - 62 cm



Fascia Antisudore
Anti-Sweat Band
Bande Anti-Sueur

Regolazione Automatica
Automatic Adjustment
Ajustement Automatique

Art.		☐	☑	€
16 031 00B	○	6	12	
16 031 00G	●	6	12	
16 031 00R	●	6	12	

16 033 - CANTIERE

Elmetto di Protezione
Protective Helmet
Casque de Sécurité

UNI-EN 397
-20° + 50°
size 53 - 62 cm



Fascia Antisudore
Anti-Sweat Band
Bande Anti-Sueur

Rotella di Regolazione
Adjustment Knob
Bouton de Réglage

Art.		☐	☑	€
16 033 00B	○	6	12	
16 033 00G	●	6	12	
16 033 00R	●	6	12	

INDICE - INDEX

ART	PAG	ART	PAG	ART	PAG	ART	PAG
01 001	3	06 193	33	12 293	24	15 427	66
01 002	3	06 194	33	12 295	24	15 428	66
01 007	3	06 196	33	12 301	24	15 429	66
01 008	5	06 301	35	12 310	24	15 432	67
01 009	4	07 110	15	14 117	54	15 433	67
01 010	4	07 112	15	14 118	54	15 436	66
01 011	5	07 113	15	15 070	63	15 437	66
02 014	6	07 188	36	15 072	63	15 439	66
02 015	6	07 191	36	15 075	62	15 450	57
02 020	7	07 192	36	15 078	63	15 454	57
02 026	7	07 193	36	15 080	63	15 455	56
04 028	18	07 195	36	15 085	62	15 456	57
04 030	18	07 250	37	15 087	62	15 458	57
04 031	18	07 251	37	15 093	62	15 459	57
04 033	18	07 252	37	15 099	62	15 465	56
04 034	17	07 260	37	15 120	55	15 508	62
04 036	17	07 261	37	15 121	55	15 509	62
04 039	17	07 270	38	15 122	55	15 510	62
04 040	18	07 271	38	15 123	55	15 600	69
05 503	15	07 280	37	15 127	54	15 601	69
05 571	14	07 281	37	15 211	67	15 624	35
05 59	13	07 290	36	15 267	38	15 625	58
05 60	14	10 060	41	15 360	70	15 813	67
05 63	13	10 061	41	15 361	70	15 821	64
05 65	12	10 070	41	15 362	70	15 822	64
05 70	10	10 071	41	15 363	70	15 823	64
05 71	9	10 075	40	15 364	70	15 824	64
05 72	11	10 076	40	15 365	70	15 826	64
05 74	9	10 077	42	15 367	71	15 827	64
05 75	11	10 079	40	15 368	71	15 828	64
05 80	10	10 083	40	15 372	61	15 830	65
05 81	9	10 085	41	15 377	61	15 831	65
05 83	13	10 086	42	15 378	61	15 840	46
05 84	14	10 088	42	15 379	61	15 841	48
05 85	14	10 089	42	15 381	59	15 842	44
05 87	12	10 097	50	15 382	59	15 843	45
06 002	34	10 098	51	15 384	59	15 849	49
06 005	34	10 099	51	15 386	59	15 850	49
06 007	34	11 070	38	15 391	73	16 031	73
06 020	34	11 075	39	15 392	73	16 033	73
06 090	32	11 077	38	15 393	72	16 200	67
06 095	32	11 080	39	15 394	72	16 213	43
06 099	32	12 060	20	15 395	72	16 214	43
06 120	30	12 067	20	15 396	72	16 215	43
06 121	30	12 070	22	15 397	72	16 379	59
06 122	30	12 072	21	15 398	72	16 380	59
06 123	29	12 073	21	15 399	72	16 385	58
06 125	29	12 080	21	15 400	66	16 390	58
06 126	27	12 082	21	15 401	68	16 521	54
06 128	31	12 083	21	15 402	68	16 522	55
06 129	29	12 084	23	15 403	68	16 806	69
06 130	31	12 085	23	15 404	69	22 470	67
06 131	27	12 091	23	15 405	68	22 561	56
06 135	27	12 094	23	15 406	69	23 100	59
06 139	27	12 095	23	15 411	68	23 130	58
06 143	28	12 097	23	15 412	68	23 131	60
06 145	28	12 098	23	15 413	68	23 132	60
06 149	29	12 110	24	15 414	69	23 134	60
06 152	31	12 160	52	15 415	68	23 137	58
06 153	30	12 161	53	15 416	69	23 138	58
06 155	31	12 162	52	15 417	69	23 150	60
06 156	28	12 163	53	15 417	69	23 307	71
06 190	33	12 190	25	15 420	67	23 308	71
06 191	33	12 199	25	15 421	67		
06 192	33	12 292	24	15 426	66		

A

ACCESSORI PONTEGGIO	72
ACCETTA	69
ALZAIMMONDIZIA	60
ARCHETTI	64
ASTE TELESCOPICHE	71

B

BADILI	59
BORSE CARPENTIERE	56
BORSE PORTAUTENSILI	57

C

CALIBRI	36
CHIAVI PER PONTEGGIO	72
CINTURE	57
COMPARATORE	37
CORDINO DI SICUREZZA	73
CUTTER	26
CUTTER ANTINFORTUNISTICI	29
CUTTER LAMA NERA SK2	28
CUTTER LAMA TRAPEZIO	31
CUTTER PIEGHEVOLI	30

D

DOPPI METRI	16
-------------------	----

E

ELMETTI	73
---------------	----

F

FERMASTADIA	67
FESSURIMETRI	50
FILI EDILIZIA	43
FILO A PIOMBO	38
FILO DI FERRO	67
FLESSOMETRI	8
FORBICI ELETTRICISTA	34
FORBICI DA LAVORO	34

G

GESSI	24
GONIOMETRI	37

L

LAME PER CUTTER	33
LEVACHIODI	67
LEVE	67
LIVELLE	40

M

MANICI LEGNO	70
MANICI SINTEX	70
MARTELLI	68
MATITA TECNICA	20
MATITE CARPENTIERE	23
MATITE MECCANICHE	21
MATITE MURATORE	23
MATITE PER VETRO	23
MAZZETTE	68
MAZZUOLE	69
METRI A NASTRO	8
METRI IN FIBRA	18
METRI IN LEGNO	16
MINE DI RICAMBIO	20

MISCELATORI	65
MISCELATORI M14	65
MISURATORE TELESCOPICO	54
MISURATORI STRADALI	54
MOSCHETTONE PONTEGGIO	73

O

ODOMETRI	54
----------------	----

P

PALE DA NEVE	61
PALINE	55
PASTELLI	24
PENNARELLI A VERNICE	25
PENNARELLI INDELEBILI	25
PICCONI	69
PICOZZINO	69
PIEGAFERRO	67
PIOMBO	38
PISTOLE A TUBO	45
PISTOLE PER SCHIUMA	44
PISTOLE SILICONE	46
POLVERE DI RICAMBIO	52
POMPA AD ARIA	49
PONTEGGIO PROTEZIONE	72
PORTACOMPARATORE	37
PORTAUTENSILI	57
PUNTE E SCALPELLI	66

R

RASATORI	62
RASCHIAFANGO	58
RASCHIATORI	63
RASCHIETTI	32
RASTRELLI	59
RIGHE ACCIAIO	15
ROTELLE METRICHE ACCIAIO	6
ROTELLE METRICHE FIBRA	2

S

SAC A POCHE	49
SALVAMANO	66
SCALPELLI E PUNTE	66
SCOPE	60
SECCHI	69
SEGHETTO CARTONGESSO	35
SPATOLE	62
SPAZZOLE	67
SPAZZOLONI	58
SPINGIACQUA	58
SQUADRE	38
SQUADRE RETTIFICATE	38
STEATITE	24
STENDIASFALTO	58
STENDIMALTA	59

T

TEMPERAMATITE	22
TENAGLIE	67
TRACCIALINEE	52

V

VENTOSE	35
---------------	----

INDEX

A		R		FIL DE FER	67
ACCESSOIRES SCAFFOLDING	72	RAKES	59	FISSUROMETRE	50
AIR PUMP	49	S		G	
B		SAC A POCHE	49	GONIOMETRE	37
BAGS	56	SAW DRYWALL	35	GRATTOIR	32
BENDER	67	SCAFFOLDING PROTECTION	72	GRATTOIR TREMPE	63
BLADES	33	SCISSORS	34	L	
BRICKLAYER THREAD	43	SCRAPERS	32	LAMES	33
BROOMS	60	SCRAPERS HARDENED	63	LEVIER	67
BROOMS INDUSTRIAL	58	SHARPENER	22	M	
BRUSH	67	SHOVEL DUST	60	MAILLET	69
C		SHOVELS	59	MALAXEURS	65
CALLIPERS	36	SNOW SHOVELS	61	MANCHE	70
CAULKING GUNS	46	SPATULAS	62	MANCHE TELESCOPIQUE	71
CHALK LINE REELS	52	SQUARES	38	MARQUER	25
CHALKS	24	STAVE TELESCOPIC	54	MARTEAU	68
CHISELS	66	STEATITE	24	METRE DE POCHE	8
CRACK MONITOR	50	STEEL RULES	15	METRE PLIANT	16
CUTTER	26	SUCTION PAD	35	METRE RUBAN	2
F		T		METRE TELESCOPIQUE	54
FOAM GUNS	44	TELESCOPIC HANDLES	71	MINES	20
FOLDING RULES	16	TOOL HOLDER	57	N	
G		W		NIVEAUX	40
GONIOMETERS	37	WRENCHES	72	O	
GUNS SILICONE	46			ODOMETRE	54
H		A		P	
HACKSAW	64	ACCESSOIRES ECHAFAUDAGE	72	PELLE	59
HAMMERS	68	B		PELLE A NEIGE	61
HAND PROTECTOR	66	BALAI	60	PELLE BALAYACE	60
HANDLES	70	BALAI CHANTIER	58	PERCHE	55
HELMETS	73	BOITE A OUTILS	56	PIED A COULISSE	36
I		BROSSE	67	PIOCHE	69
IRON WIRE	67	BURIN	66	PISTOLET MOUSSE	44
L		C		PISTOLET SILICONE	46
LEADS	20	CASQUE	73	PLATOIR	62
LEVELS	40	CHEVILLETTTE	67	POMPE SOUFFLANTE	49
LEVERS	67	CINTREUSE	67	PORTE OUTILS	57
M		CISEAUX	34	PORTEMINE	20
MALLETS	69	CLE ECHAFAUDAGE	72	POUDRE	52
MARKERS	25	CORDEAU TRESSE	43	PROTEGE MAIN	66
MEASURING WHEEL	54	CRAIE	24	R	
MECHANICAL PENCIL	20	CRAYON	23	RATEAU	59
METRIC TAPELINE	2	CRAYON INDUSTRIEL	24	REGLE ACIER	15
MIXER	65	CUTTER	26	S	
P		E		SAC A POCHE	49
PAILS	69	ECHAFAUDAGE PROTECTION	72	SCIE	64
PASTELS	24	EQUERRE	38	SCIE CLOISON SECHE	35
PEGS	67	F		SEAU	69
PENCILS	23	FIL A PLOMB	38	SPATULE	62
PICKAXE	69			STEATITE	24
PINCERS	67			T	
PLASTERING SCRAPERS	62			TAILLE CRAYON	22
PLUMB BOB	38			TENAILLE	67
POCKET STEEL TAPES	8			TRACE LIGNES	52
POLES	55			V	
POWDER	52			VENTOUSE	35

TRASPORTO per 100kg €		€	
Lombardia	10,00	Umbria	12,50
Piemonte	10,00	Lazio	12,50
Valle d'Aosta	10,00	Abruzzo	12,50
Veneto	10,00	Campania	12,50
Trentino	10,00	Puglia	12,50
Friuli Venezia Giulia	10,00	Molise	15,00
Liguria	10,00	Basilicata	15,00
Emilia Romagna	10,00	Calabria	15,00
Toscana	12,50	Sardegna	20,00
Marche	12,50	Sicilia	20,00

 L'ordine si intende conferito od assunto "salvo approvazione della casa". L'approvazione viene manifestata con conferma o anche con la sola evasione dell'ordine. Con il conferimento dell'ordine si intendono accettate interamente le condizioni generali di vendita.

Per ogni ordinazione attenersi all'unità di vendita e relativo multiplo. Ci riteniamo autorizzati a modificare d'ufficio eventuali quantità non corrispondenti all'unità di vendita.

La spedizione è effettuata in porto franco con addebito in fattura se il trasposto viene eseguito da un corriere con noi convenzionato. La spedizione è effettuata in porto assegnato se il trasposto viene richiesto un corriere con noi non convenzionato.

Non si accettano ordini inferiori a Euro 150,00 Iva Esclusa.

Gli ordini vengono evasi, anche parzialmente, secondo disponibilità di magazzino. I termini di consegna eventualmente espressi sono indicativi e mai impegnativi. È nostra facoltà, secondo la disponibilità di magazzino, annullare o dilazionare le quantità non consegnate nei termini concordati.

Per articoli non disponibili, di ordini evasi parzialmente, il residuo che si renderà disponibile verrà spedito in porto franco se raggiungerà il minimo fatturabile di Euro 100,00 a meno che non vi siano altri ordini in corso evadibili come da ns. condizioni di vendita.

I prezzi, in linea di massima, saranno accettati ed evasi conformi alle condizioni di acquisizione. ci riserviamo comunque (per casi eccezionali di condizioni di mercato) di variare le quotazioni in qualsiasi momento.

Le illustrazioni, le caratteristiche e tutte le altre indicazioni descritte sul catalogo si intendono approssimative, riservandoci di apportare tutte quelle modifiche che, a nostro giudizio, costituiscono migliorie, senza che ciò possa giustificare reclamo da parte del committente.

La merce viaggia a totale rischio e pericolo del committente anche se venduta franco destino. Eventuali irregolarità circa la quantità e la qualità, nonché ogni altro eventuale vizio o difformità relativamente alla merce consegnata dovranno essere rilevati dall'acquirente, all'atto del ricevimento. Poiché si verificano casi di ammanchi o danneggiamenti per merci spedite tramite corriere si raccomanda di controllare scrupolosamente la merce in arrivo e far sottoscrivere al consegnatario eventuali difformità. Ogni ammanco, ritardo o disguido dovrà essere contestato al vettore. Trascorso il termine di 8 giorni dal ricevimento della merce decade il diritto di presentare reclami relativi a vizi o altre difformità non appartenenti all'atto del ricevimento.

Non si accettano resi se non preventivamente autorizzati con lettera scritta, e mai per merce serigrafata del cliente o merce su richiesta. Per la merce che sarà restituita dovranno essere indicati sulla bolla di reso gli estremi delle bolle di accompagnamento e fatture di acquisto.

Il reso dovrà pervenirci in porto franco altrimenti verrà respinto.

Il pagamento della fattura deve essere effettuato entro i termini stabiliti presso la nostra sede o a persona da noi autorizzata. Non sono ammesse trattenute arbitrarie ed arrotondamenti. Trascorsi 7gg dal termine di pagamento si intendono revocati gli sconti di pagamento e le fatture dovranno essere pagate per intero.

In caso di mancato pagamento, parziale o totale di una fornitura, anche se contestata da parte dell'acquirente, ci riserviamo il diritto di sospendere ogni altra consegna successiva, anche dipendente da altri contratti, o di ritenere risolto il contratto per fatto e colpa dell'acquirente. In caso di ritardato pagamento delle fatture, saranno addebitati interessi di mora nella misura al momento praticata da primarie Banche Italiane per scoperti di conto corrente. L'interesse di mora sarà applicato per il periodo intercorrente dalla scadenza della fattura al pagamento effettivo del saldo con sovrapprezzo di € 25,82 (spese amm.) per ogni insoluto di R.B.

L'acquirente si assume ogni responsabilità per l'uso di marchi di fabbrica, di nomi o stemmi che prescriba di apporre sui prodotti forniti. Gli stampi, i cliché, i bozzetti ecc. restano in esclusiva proprietà della fornitrice, anche se l'acquirente ne ha sostenuto in parte o per intero il costo.

Per qualsiasi controversia è esclusivamente competente il Foro di Varese.



By placing the order the customer accepts without reserve the following conditions.

Goods are delivered ex our warehouse. The cost for different delivery condition will be invoiced to the customer.

Goods travel at consignee's risk even if under terms of sale: free place of destination.

Complaints for defects or statements of shortage of goods will be taken into consideration within 8 days from receipt of the goods.

PAYMENTS MUST BE ABSOLUTELY CARRIED OUT WITHIN THE AGREED UPON TERMS.

Foreign bank charges will be charged to the customer's account.

Any dispute between the parties will be submitted to arbitration in Varese - Italy before the competent court under its rules.



By plant une commande s'entendent comme acceptées les conditions suivantes sans aucun réserve de votre part.

La marchandise est livrée franco départ. Le coût total pour livraison différent sera facturé.

La marchandise voyage aux risques et périls du destinataire, même si sous conditions franco destination.

Les plaintes pour défaut éventuels ou les constatations de manquant en marchandise seront prises en considération dans les 8 jours dès la réception de la marchandise.

LES PAIEMENTS SONT A EFFECTUER FORMELLEMENT DANS LES DELAIS CONVENUS.

Les frais de banque étrangère seront portés à la charge du client

En cas de contestation le tribunal de Varese - Italie est le seul compétent et la loi à appliquer sera la loi italienne.



METRO PLAST s.n.c

Via Vajone 6 - 21020 Galliate L.do (VA) ITALIA
Tel. +39 0332 947302 r.a. Fax +39 0332 949644
www.metroplast.it - mp@metroplast.it